



LIIG
CREATIVE

ITI
PROFESSIONAL

NG
TREND

2020
NEW CATALOG

Creative
Professional
Trend
Lighting Solution



skarlat.ua

LED

Contents

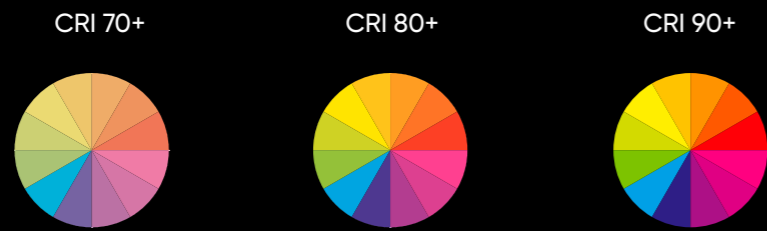

ОБЛАСТЬ ПРИМЕНЕНИЯ

Офисы
Магазины

Частные дома
Офисы
Торговые площадки

Музеи
Галереи
Изысканные рестораны
Эксклюзивные товары
в магазинах

УСЛОВНЫЕ ОБОЗНАЧЕНИЯ



LED модуль



GU10

тип цоколя



заземление

220
240 V~ 50Hz

входное напряжение



используется в помещении



соответствует европейскому стандарту EN



класс пылевлагозащиты



правильная утилизация



угол поворота



врезной светильник

01 Ceiling lights

02 Downlights

03 Pendant lights

04 Spotlights

05 Track lights

06 Wall lights

07 Floodlight

CEILING LIGHTS

стр 24-25



стр 26-27

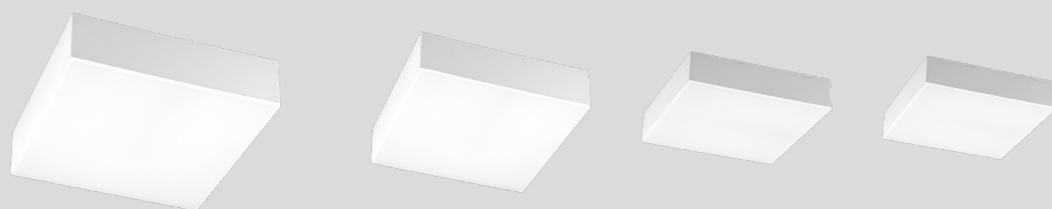

стр 20-21



стр 22-23



стр 30-31



стр 28-29

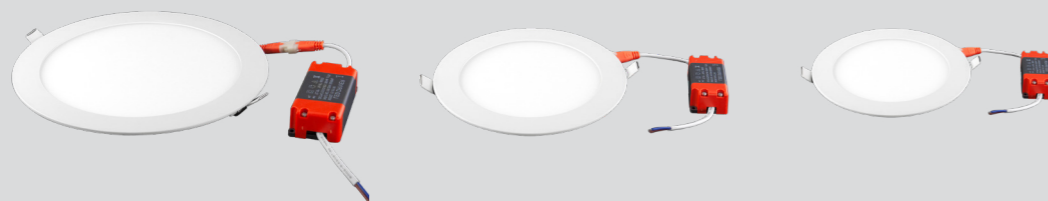

стр 32-33



стр 36-37

DOWNLIGHTS



стр 64-65

стр 74



стр 66-67

стр 75

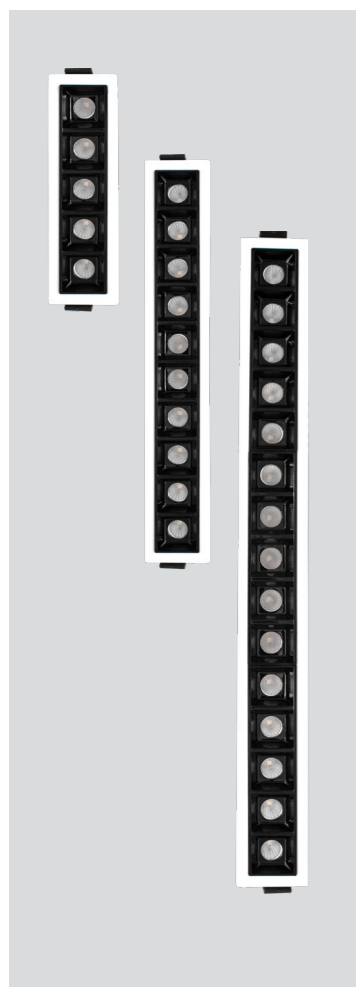

стр 90-91



стр 70

стр 71

стр 72

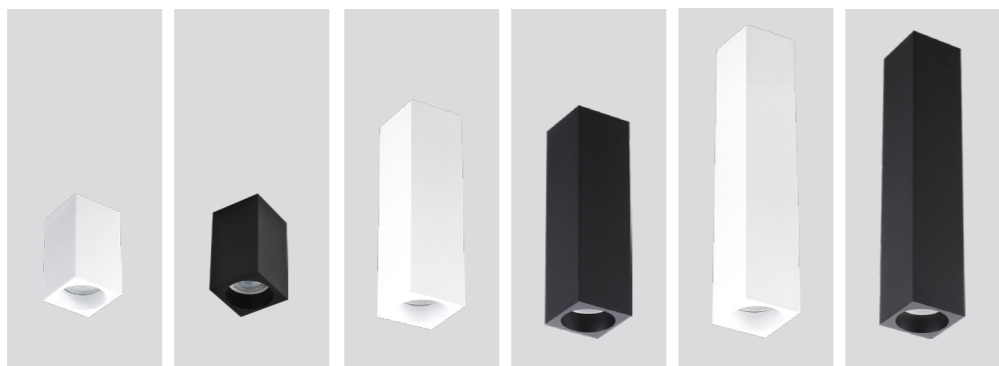

стр 76

стр 77

стр 78



стр 88-89



стр 82

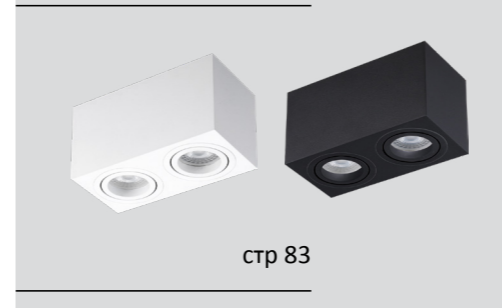

стр 83

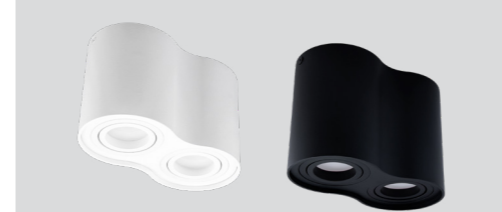

стр 80



стр 81

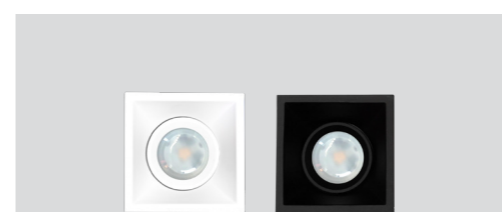

стр 56



стр 57

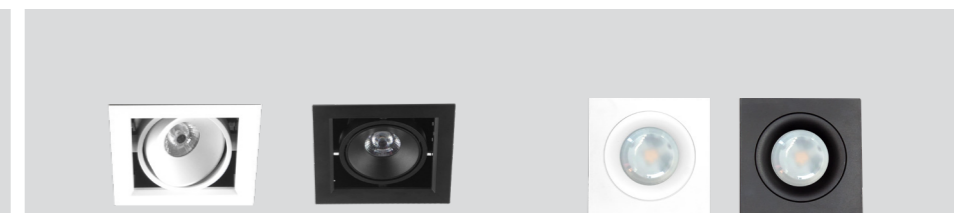

стр 84

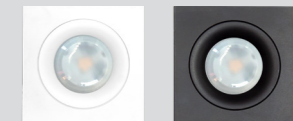

стр 58



стр 54



стр 55

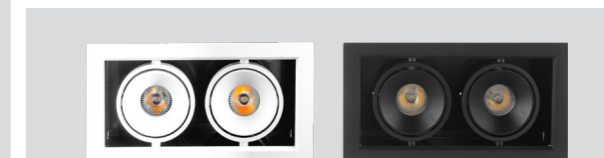

стр 86

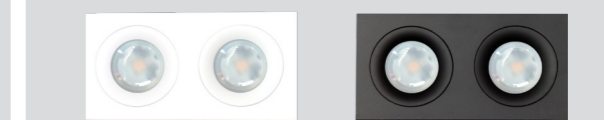

стр 58



стр 52-53



стр 62-63

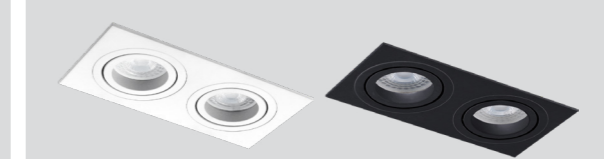

стр 60-61



стр 50



стр 51

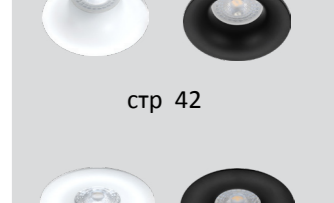

стр 42



стр 43



стр 48

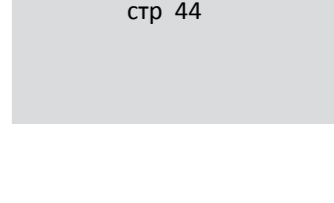

стр 44

PENDANT LIGHTS



стр 94



стр 95



стр 96



стр 98



стр 99

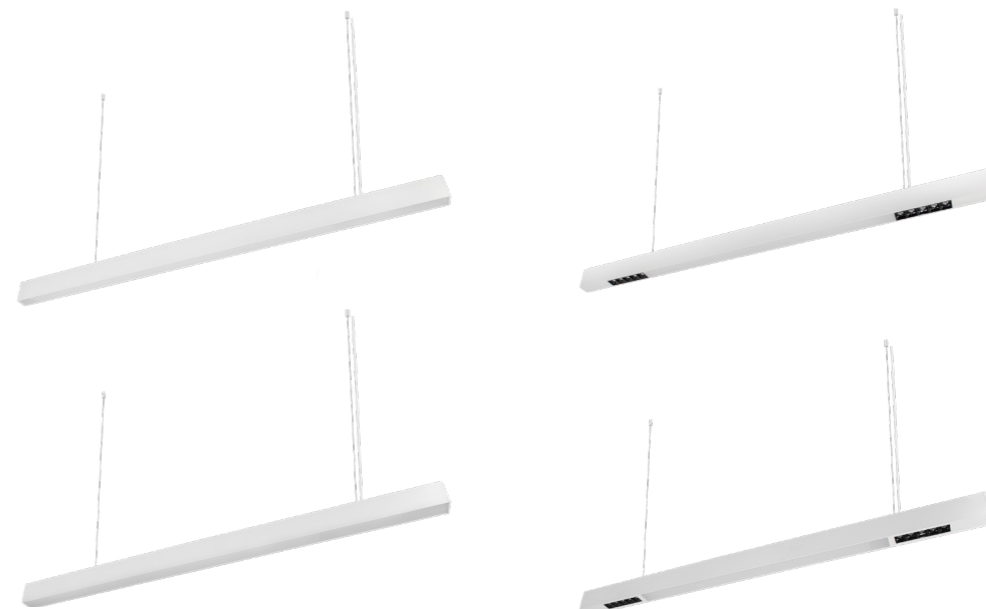

стр 100-101



стр 102-103

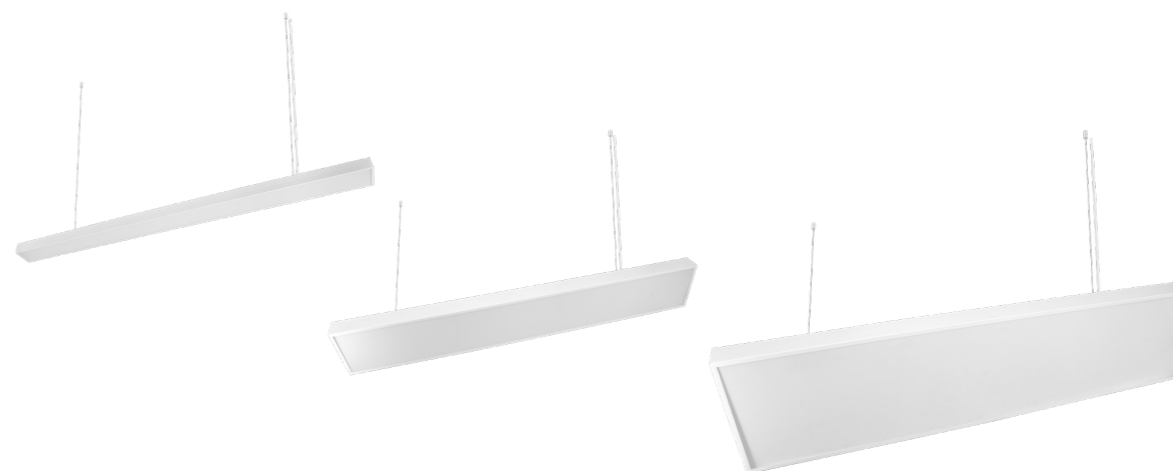

стр 104-105



стр 116

стр 117

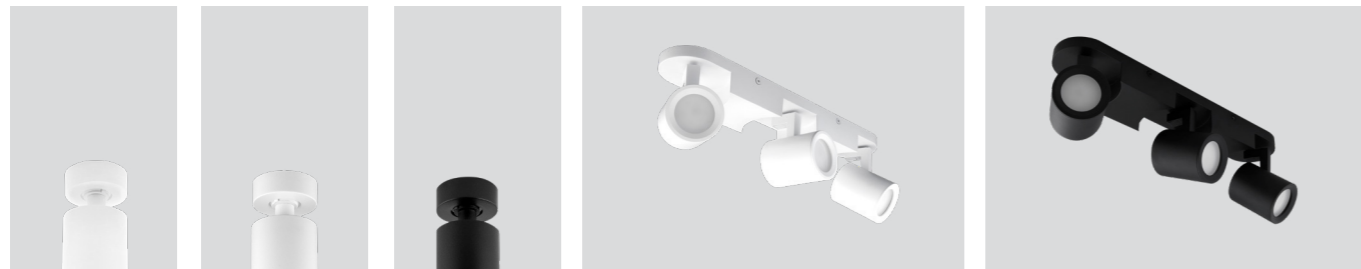

стр 118



стр 110



стр 108

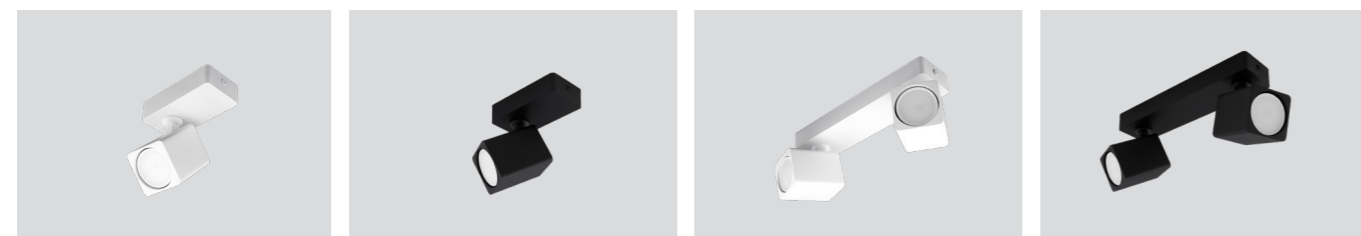

стр 120

стр 121



стр 111



стр 112



стр 114



стр 115

TRACK LIGHTS

стр 124-125

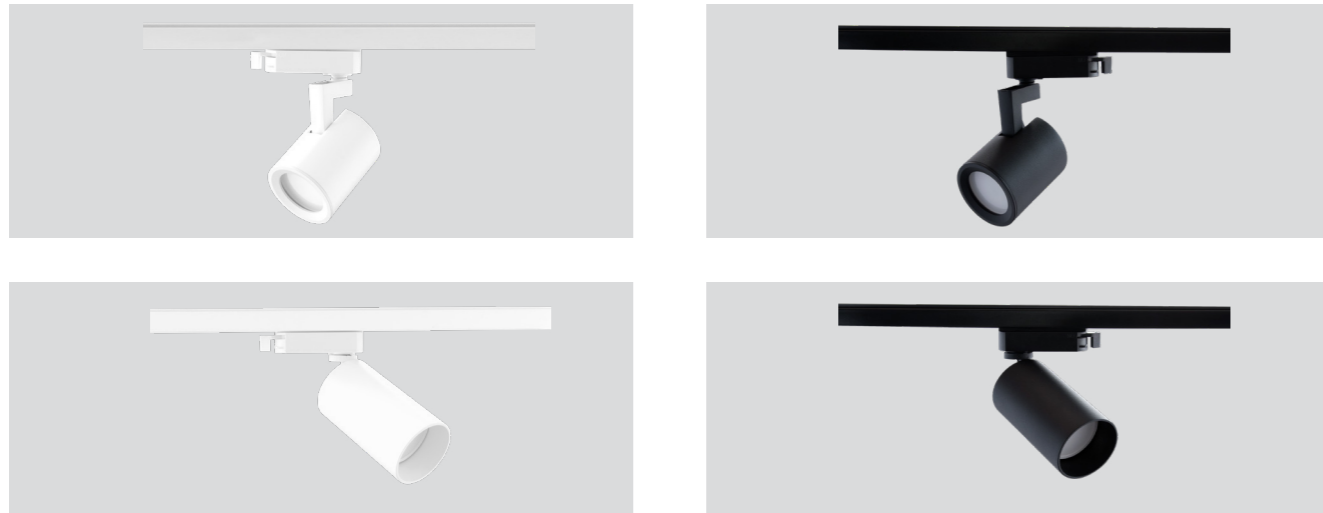

стр 128-129



стр 130-131

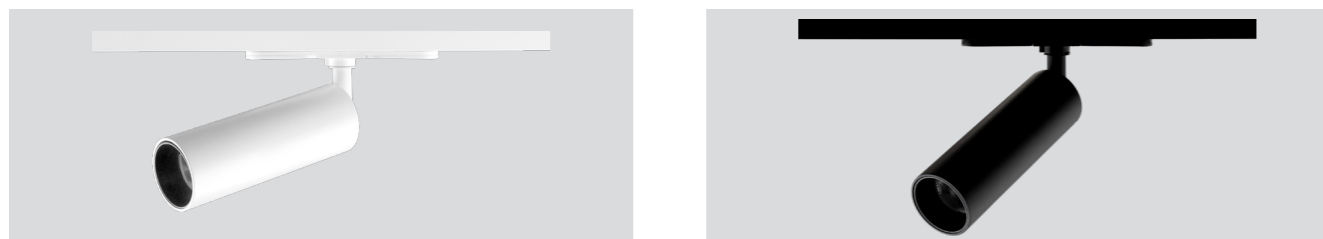

стр 132-133

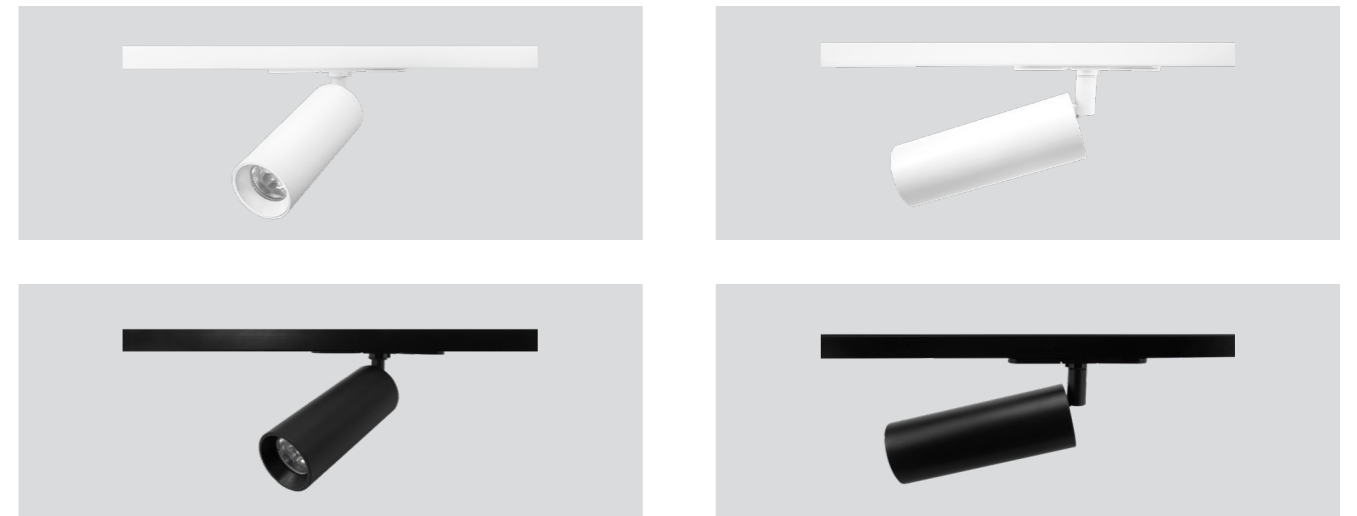

стр 134-135

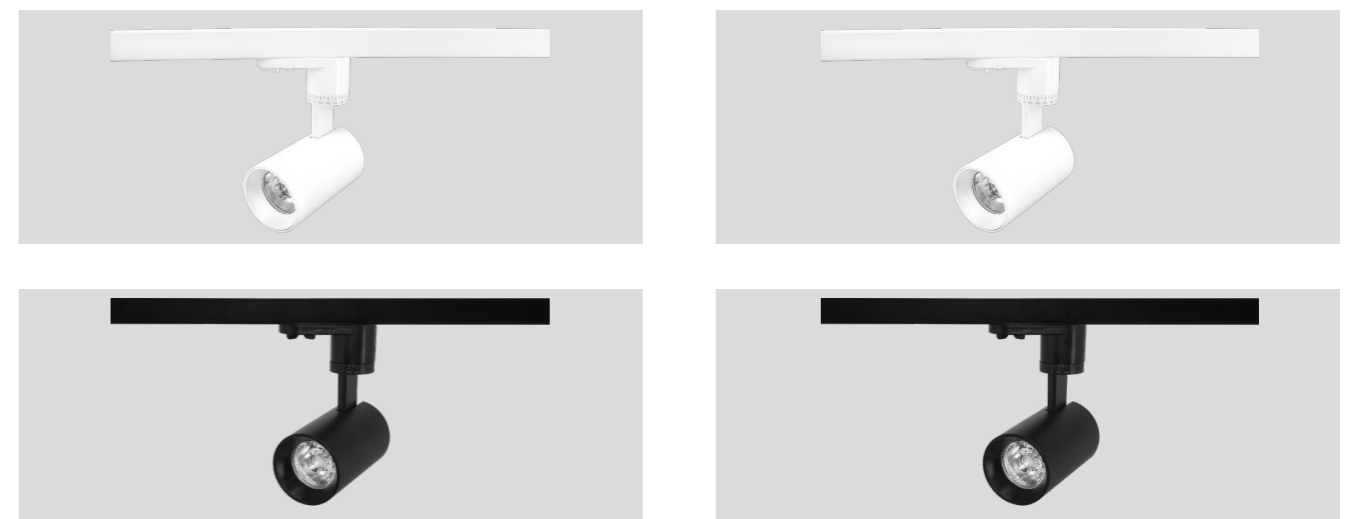

стр 136-137



стр 138-139

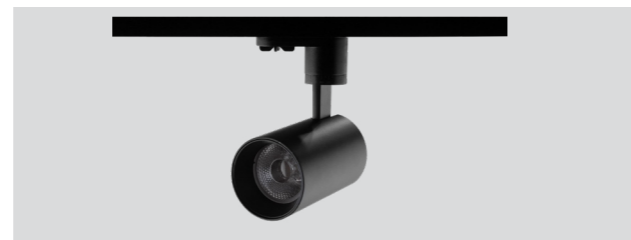

стр 140-141

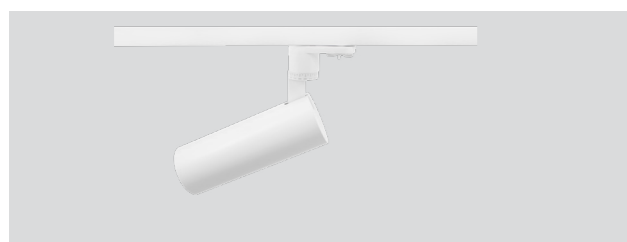

TRACK RINGS



стр 144

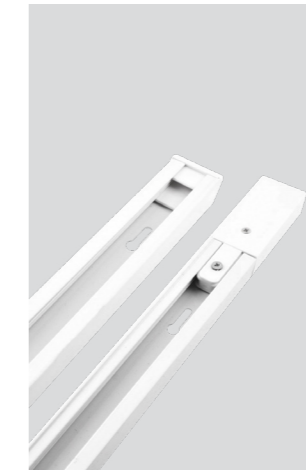

стр 142

TRACK PROFILE
TRACK CONNECTORS



стр 143

CABLE SYSTEMS FOR
HANGING TRACK

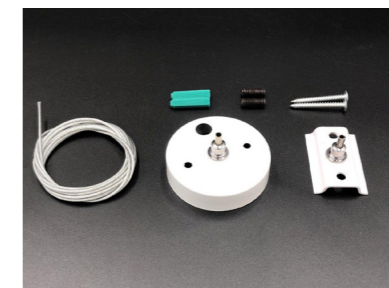

стр 143

WALL LIGHTS



стр 148



стр 150



стр 151

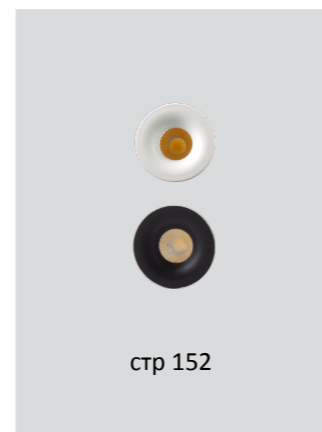

стр 152

OUTDOOR LIGHTING



стр 156-157



стр 158-159



стр 160-161

FLOODLIGHT



стр 168-169



стр 170-171



стр 162



стр 163



стр 164-165



стр 166-167



- **Ceiling lights**
series

НАКЛАДНЫЕ СВЕТИЛЬНИКИ

располагаются на потолке или стене. В основном, данный тип светильников используется в качестве основного источника света. Все представленные модели гармонично впишутся в любой интерьер.

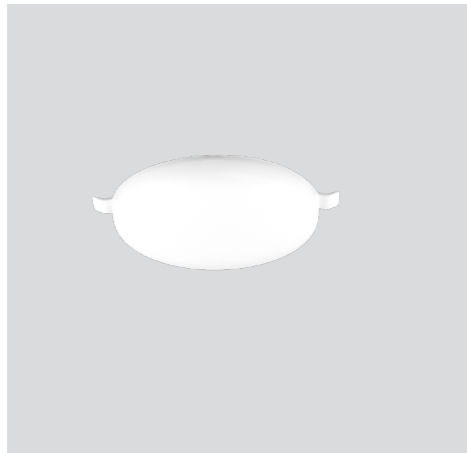

PC0005-32Q RD 5W 

Series	Ceiling lights
LED	SMD 2835
CCT	6000K
CRI	RA ≥ 70
Power	5w
Luminous Flux	450 Lm
Beam Angle	120°
Color	White
Material	Plastic
Size	D 70 x H 25

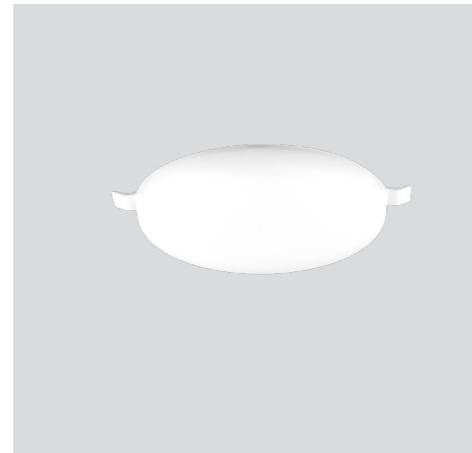

PC0007-32Q RD 7W 

Series	Ceiling lights
LED	SMD 2835
CCT	6000K
CRI	RA ≥ 70
Power	7w
Luminous Flux	630 Lm
Beam Angle	120°
Color	White
Material	Plastic
Size	D 110 x H 35

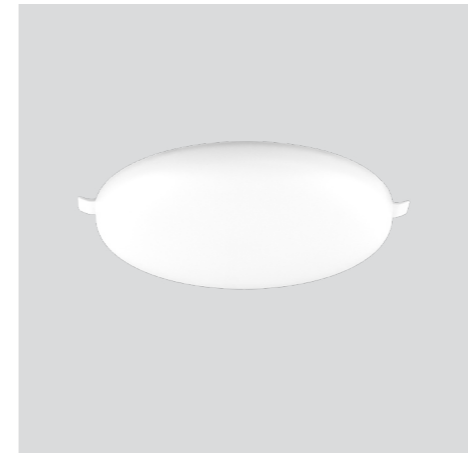

PC0012-32Q RD 12W 

Series	Ceiling lights
LED	SMD 2835
CCT	6000K
CRI	RA ≥ 70
Power	12w
Luminous Flux	1080 Lm
Beam Angle	120°
Color	White
Material	Plastic
Size	D 155 x H 35

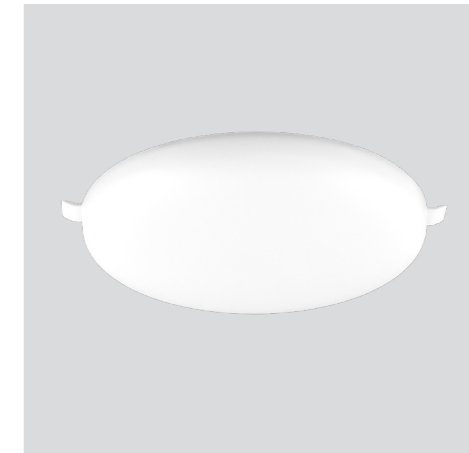

PC0018-32Q RD 18W 

Series	Ceiling lights
LED	SMD 2835
CCT	6000K
CRI	RA ≥ 70
Power	18w
Luminous Flux	1620 Lm
Beam Angle	120°
Color	White
Material	Plastic
Size	D 190 x H 35

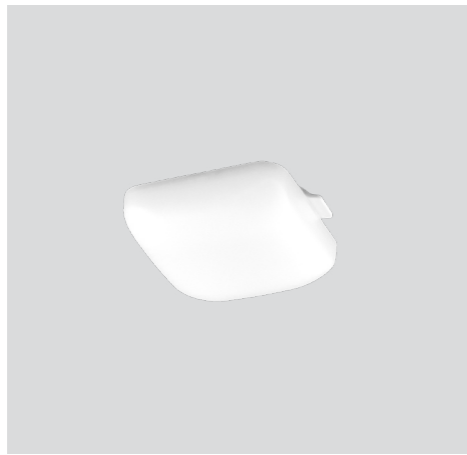

PC0005-32Q SQ 5W 

Series	Ceiling lights
LED	SMD 2835
CCT	6000K
CRI	RA ≥ 70
Power	5w
Luminous Flux	450 Lm
Beam Angle	120°
Color	White
Material	Plastic
Size	L 70 x W 70 x H 25

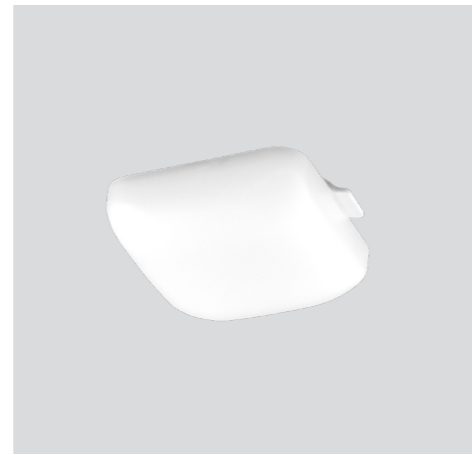

PC0007-32Q SQ 7W 

Series	Ceiling lights
LED	SMD 2835
CCT	6000K
CRI	RA ≥ 70
Power	7w
Luminous Flux	630 Lm
Beam Angle	120°
Color	White
Material	Plastic
Size	L 110 x W 110 x H 35

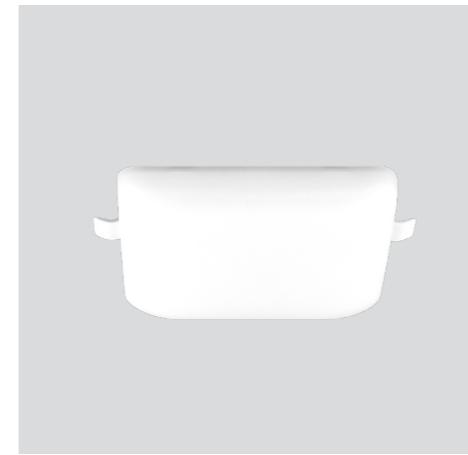

PC0012-32Q SQ 12W 

Series	Ceiling lights
LED	SMD 2835
CCT	6000K
CRI	RA ≥ 70
Power	12w
Luminous Flux	1080 Lm
Beam Angle	120°
Color	White
Material	Plastic
Size	L 155 x W 155 x H 35



PC0018-32Q SQ 18W 

Series	Ceiling lights
LED	SMD 2835
CCT	6000K
CRI	RA ≥ 70
Power	18w
Luminous Flux	1620 Lm
Beam Angle	120°
Color	White
Material	Plastic
Size	L 190 x W 190 x H 35

PC0006-32HSF RD 6W



Series	Ceiling lights
LED	SMD 2835
CCT	6000K
CRI	RA ≥ 70
Power	6w
Luminous Flux	480 Lm
Beam Angle	120 °
Color	White
Material	Plastic
Size	D 91 x H 27



PC0018-32HSF RD 18W



Series	Ceiling lights
LED	SMD 2835
CCT	6000K
CRI	RA ≥ 70
Power	18w
Luminous Flux	1440 Lm
Beam Angle	120 °
Color	White
Material	Plastic
Size	D156 x H 27



PC0012-32HSF RD 12W



Series	Ceiling lights
LED	SMD 2835
CCT	6000K
CRI	RA ≥ 70
Power	12w
Luminous Flux	960 Lm
Beam Angle	120 °
Color	White
Material	Plastic
Size	D 120 x H 27



PC0024-32HSF RD 24W



Series	Ceiling lights
LED	SMD 2835
CCT	6000K
CRI	RA ≥ 70
Power	24w
Luminous Flux	1920 Lm
Beam Angle	120 °
Color	White
Material	Plastic
Size	D 190 x H 27



PC0006-32HSF SQ 6W



Series	Ceiling lights
LED	SMD 2835
CCT	6000K
CRI	RA ≥ 70
Power	6w
Luminous Flux	480 Lm
Beam Angle	120 °
Color	White
Material	Plastic
Size	L 90 x W 90 x H 27



PC0018-32HSF SQ 18W



Series	Ceiling lights
LED	SMD 2835
CCT	6000K
CRI	RA ≥ 70
Power	18w
Luminous Flux	1440 Lm
Beam Angle	120 °
Color	White
Material	Plastic
Size	L 156 x W 156 x H 27



PC0012-32HSF SQ 12W



Series	Ceiling lights
LED	SMD 2835
CCT	6000K
CRI	RA ≥ 70
Power	12w
Luminous Flux	960 Lm
Beam Angle	120 °
Color	White
Material	Plastic
Size	L 120 x W 120 x H 27



PC0024-32HSF SQ 24W



Series	Ceiling lights
LED	SMD 2835
CCT	6000K
CRI	RA ≥ 70
Power	24w
Luminous Flux	1920 Lm
Beam Angle	120 °
Color	White
Material	Plastic
Size	L 190 x W 190 x H 27



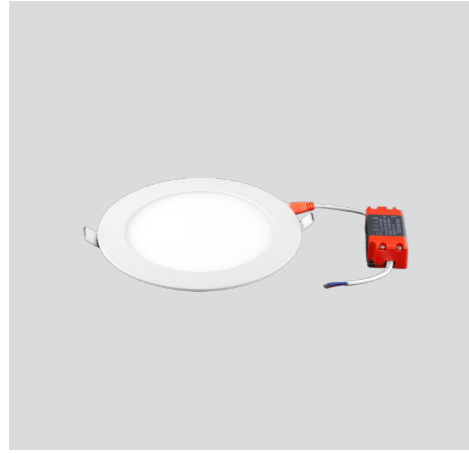

PC0006-14 RD 6W 

Series	Ceiling lights
LED	SMD 2835
CCT	6000K
CRI	RA ≥ 80
Power	6w
Luminous Flux	400 Lm
Beam Angle	120 °
Color	White
Material	Aluminum
Size	D 120 x H 18



PC0012-14 RD 12W 

Series	Ceiling lights
LED	SMD 2835
CCT	6000K
CRI	RA ≥ 80
Power	12w
Luminous Flux	840 Lm
Beam Angle	120 °
Color	White
Material	Aluminum
Size	D 172 x H 18



PC0018-14 RD 18W 

Series	Ceiling lights
LED	SMD 2835
CCT	6000K
CRI	RA ≥ 80
Power	18w
Luminous Flux	1350 Lm
Beam Angle	120 °
Color	White
Material	Aluminum
Size	D 225 x H 18



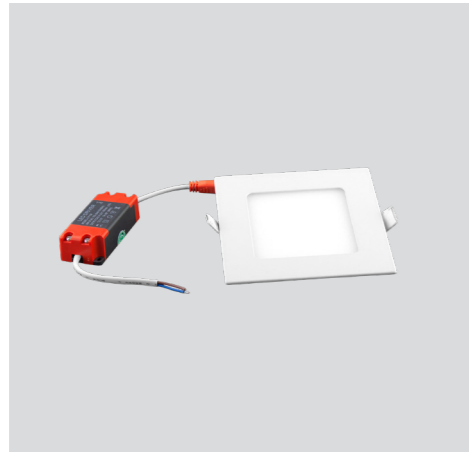

PC0006-14 SQ 6W 

Series	Ceiling lights
LED	SMD 2835
CCT	6000K
CRI	RA ≥ 80
Power	6w
Luminous Flux	400 Lm
Beam Angle	120 °
Color	White
Material	Aluminum
Size	L 120 x W 120 x H 20

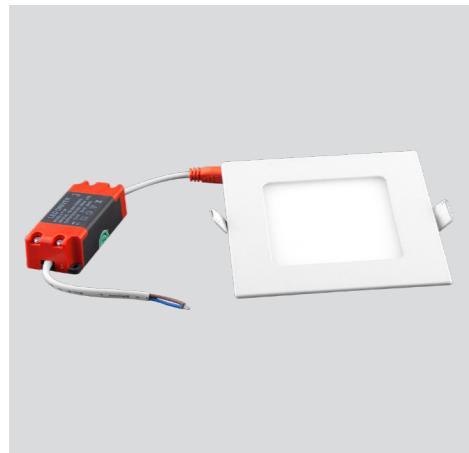

PC0012-14 SQ 12W 

Series	Ceiling lights
LED	SMD 2835
CCT	6000K
CRI	RA ≥ 80
Power	12w
Luminous Flux	840 Lm
Beam Angle	120 °
Color	White
Material	Aluminum
Size	L 172 x W 172 x H 20

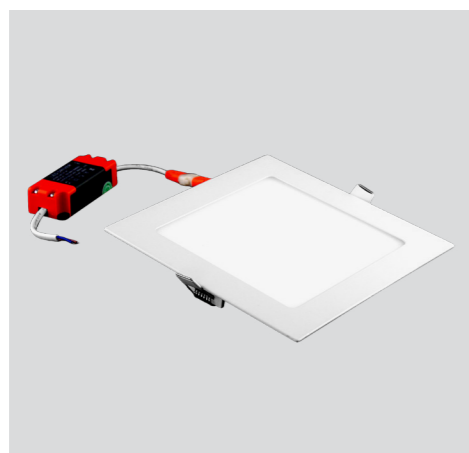

PC0018-14 SQ 18W 

Series	Ceiling lights
LED	SMD 2835
CCT	6000K
CRI	RA ≥ 80
Power	18w
Luminous Flux	1350 Lm
Beam Angle	120 °
Color	White
Material	Aluminum
Size	L 225 x W 225 x H 20





D519A-LED 5w WH



Series	Ceiling lights
LED	SMD 2835
CCT	3000K/4000K
CRI	RA ≥ 80
Power	5w
Luminous Flux	450 Lm
Beam Angle	90°
Color	White
Material	Aluminum
Size	D 82 x H 80



D519D-LED 18w WH



Series	Ceiling lights
LED	SMD 2835
CCT	3000K/4000K
CRI	RA ≥ 80
Power	18w
Luminous Flux	1620 Lm
Beam Angle	90°
Color	White
Material	Aluminum
Size	D 147 x H 105



D519B-LED 7w WH



Series	Ceiling lights
LED	SMD 2835
CCT	3000K/4000K
CRI	RA ≥ 80
Power	7w
Luminous Flux	630 Lm
Beam Angle	90°
Color	White
Material	Aluminum
Size	D 95 x H 80



D519E-LED 24w WH



Series	Ceiling lights
LED	SMD 2835
CCT	3000K/4000K
CRI	RA ≥ 80
Power	24w
Luminous Flux	2160 Lm
Beam Angle	90°
Color	White
Material	Aluminum
Size	D 175 x H 105



D519C-LED 12w WH



Series	Ceiling lights
LED	SMD 2835
CCT	3000K/4000K
CRI	RA ≥ 80
Power	12w
Luminous Flux	1080 Lm
Beam Angle	90°
Color	White
Material	Aluminum
Size	D 128 x H 90



D519F-LED 30w WH



Series	Ceiling lights
LED	SMD 2835
CCT	3000K/4000K
CRI	RA ≥ 80
Power	30w
Luminous Flux	2700 Lm
Beam Angle	90°
Color	White
Material	Aluminum
Size	D 220 x H 110





D519A-LED 5W BK



Series	Ceiling lights
LED	SMD 2835
CCT	3000K/4000K
CRI	RA ≥ 80
Power	5w
Luminous Flux	450 Lm
Beam Angle	90 °
Color	Black
Material	Aluminum
Size	D 82 x H 80



D519B-LED 7W BK



Series	Ceiling lights
LED	SMD 2835
CCT	3000K/4000K
CRI	RA ≥ 80
Power	7w
Luminous Flux	630 Lm
Beam Angle	90 °
Color	Black
Material	Aluminum
Size	D 95 x H 80



D519C-LED 12W BK



Series	Ceiling lights
LED	SMD 2835
CCT	3000K/4000K
CRI	RA ≥ 80
Power	12w
Luminous Flux	1080 Lm
Beam Angle	90 °
Color	Black
Material	Aluminum
Size	D 128 x H 90



D519D-LED 18W BK



Series	Ceiling lights
LED	SMD 2835
CCT	3000K/4000K
CRI	RA ≥ 80
Power	18w
Luminous Flux	1620 Lm
Beam Angle	90 °
Color	Black
Material	Aluminum
Size	D 147 x H 105



D519E-LED 24W BK



Series	Ceiling lights
LED	SMD 2835
CCT	3000K/4000K
CRI	RA ≥ 80
Power	24w
Luminous Flux	2160 Lm
Beam Angle	90 °
Color	Black
Material	Aluminum
Size	D 175 x H 105



D519F-LED 30W BK



Series	Ceiling lights
LED	SMD 2835
CCT	3000K/4000K
CRI	RA ≥ 80
Power	30w
Luminous Flux	2700 Lm
Beam Angle	90 °
Color	Black
Material	Aluminum
Size	D 220 x H 110





• Downlights

series

ТОЧЕЧНЫЕ СВЕТИЛЬНИКИ

это безусловный лидер среди наиболее популярных решений для создания проектов освещения. Применяются как в качестве второстепенных акцентов в помещении, так и основных источников света. Серия наполнена разнообразными моделями, которые отличаются современным дизайном и исполнением.



TH3913 WH GU10



Series	Downlight
Lamp	GU10 MAX 50W
Color	White
Material	Aluminum
Size	D 90 x H 42



TH3911 WH GU10



Series	Downlight
Lamp	GU10 MAX 50W
Color	White
Material	Aluminum
Size	D 98 x H 25



TH3913 BK GU10



Series	Downlight
Lamp	GU10 MAX 50W
Color	Black
Material	Aluminum
Size	D 90 x H 42



TH3911 BK GU10



Series	Downlight
Lamp	GU10 MAX 50W
Color	Black
Material	Aluminum
Size	D 98 x H 25

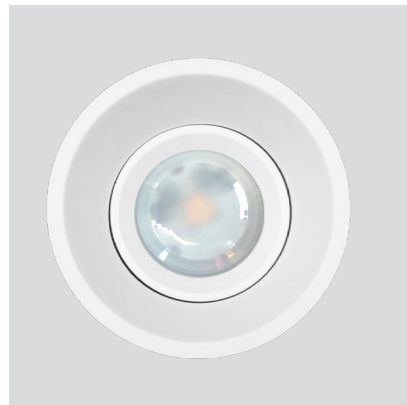

AK-219A WH GU10



Series	Downlight
Lamp	GU10 MAX 50W
Color	White
Material	Aluminum
Size	D 92 x H 42



AK-219A BK GU10



Series	Downlight
Lamp	GU10 MAX 50W
Color	Black
Material	Aluminum
Size	D 92 x H 42



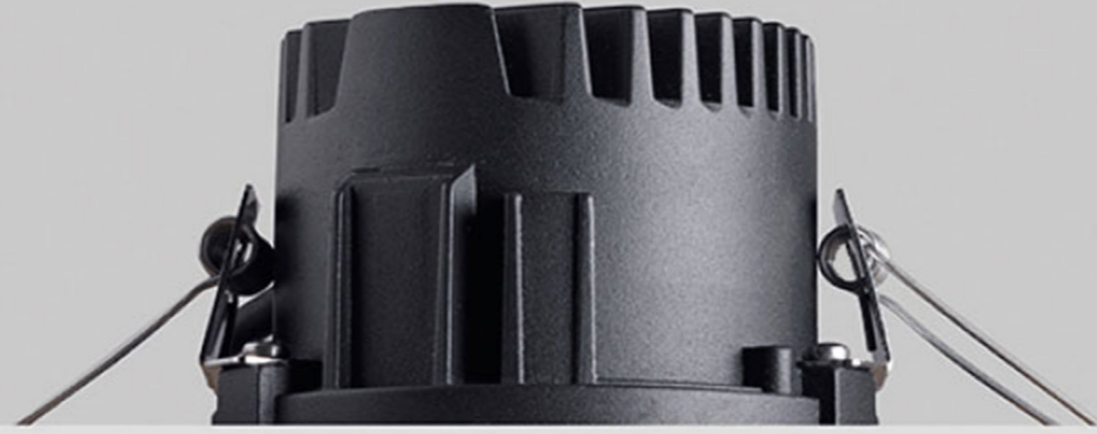

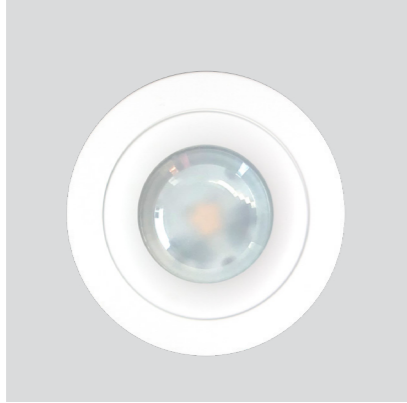

AK-747E WH GU10



Series	Downlight
Lamp	GU10 MAX 50W
Color	White
Material	Aluminum
Size	D 94 x H 23



AK-747E BK GU10



Series	Downlight
Lamp	GU10 MAX 50W
Color	Black
Material	Aluminum
Size	D 94 x H 23





TH3529 WH GU10



Series	Downlight
Lamp	GU10 MAX 50W
Color	White
Material	Aluminum
Size	D 100 x H 30



TH5808 WH GU10



Series	Downlight
Lamp	GU10 MAX 50W
Color	White
Material	Aluminum
Size	D 92 x H 25



TH3529 BK GU10



Series	Downlight
Lamp	GU10 MAX 50W
Color	Black
Material	Aluminum
Size	D 100 x H 30



TH5808 BK GU10



Series	Downlight
Lamp	GU10 MAX 50W
Color	Black
Material	Aluminum
Size	D 92 x H 25

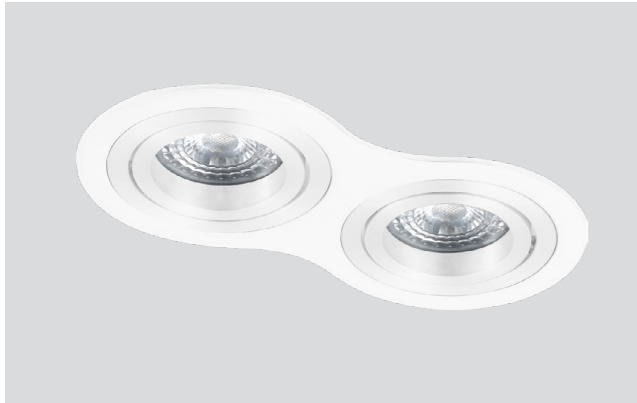

TH5812 WH 2XGU10 

Series	Downlight
Lamp	GU10 MAX 50W
Color	White
Material	Aluminum
Size	L 173 x D 89 x H 24



TH5812 BK 2XGU10 

Series	Downlight
Lamp	GU10 MAX 50W
Color	Black
Material	Aluminum
Size	L 173 x D 89 x H 24





TH3912 WH GU10



Series	Downlight
Lamp	GU10 MAX 50W
Color	White
Material	Aluminum
Size	L 98 x W 98 x H 27



TH5809 WH GU10



Series	Downlight
Lamp	GU10 MAX 50W
Color	White
Material	Aluminum
Size	L 92 x W 92 x H 25

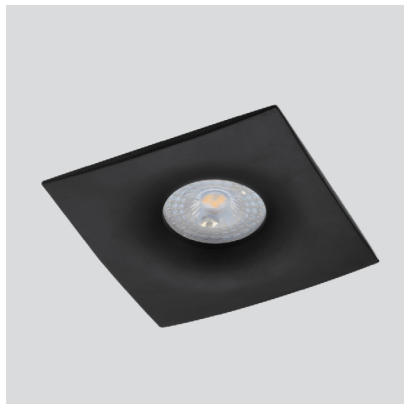

TH3912 BK GU10



Series	Downlight
Lamp	GU10 MAX 50W
Color	Black
Material	Aluminum
Size	L 98 x W 98 x H 27

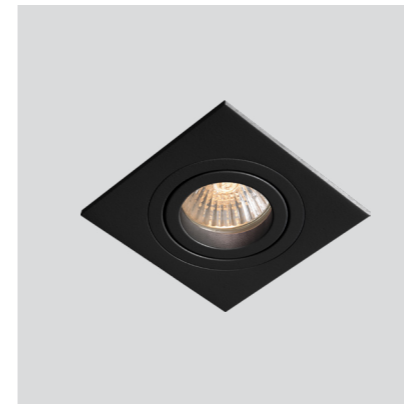

TH5809 BK GU10



Series	Downlight
Lamp	GU10 MAX 50W
Color	Black
Material	Aluminum
Size	L 92 x W 92 x H 25

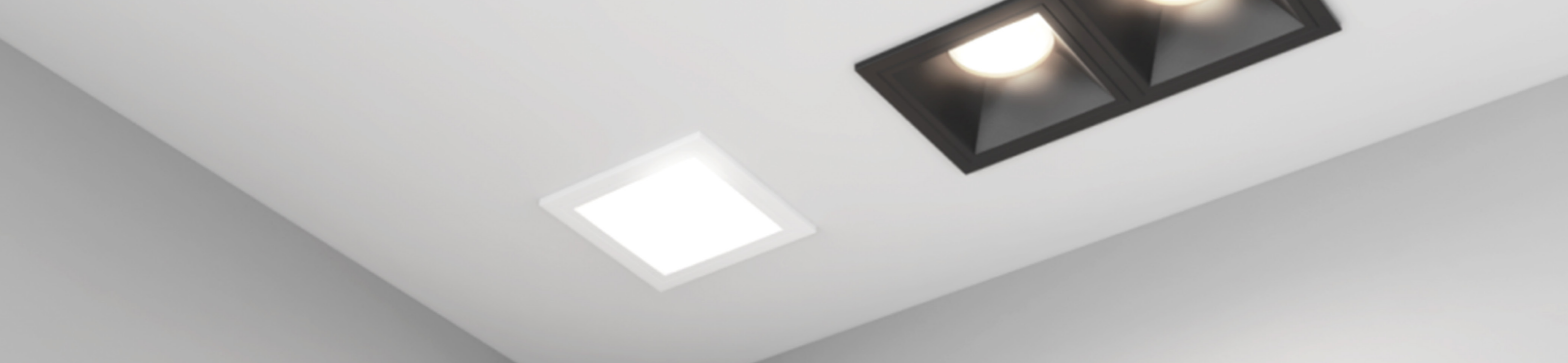

AK-220A WH GU10



Series	Downlight
Lamp	GU10 MAX 50W
Color	White
Material	Aluminum
Size	L 90 x W 90 x H 42



TH 3530 WH GU10



Series	Downlight
Lamp	GU10 MAX 50W
Color	White
Material	Aluminum
Size	L 100 x W 100 x H 30

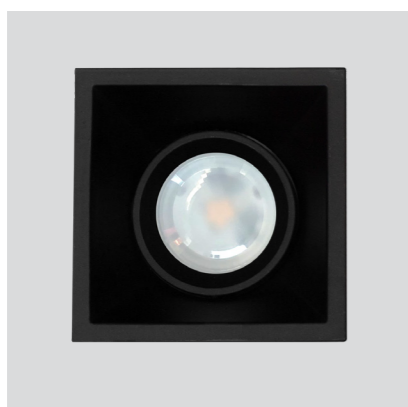

AK-220A BK GU10



Series	Downlight
Lamp	GU10 MAX 50W
Color	Black
Material	Aluminum
Size	L 90 x W 90 x H 42

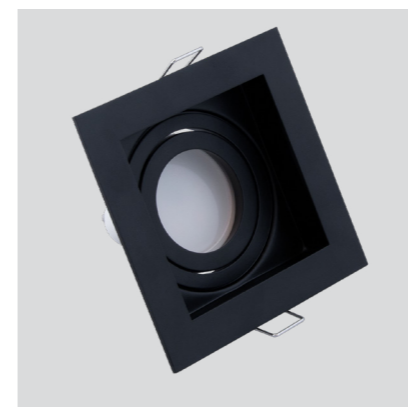

TH 3530 BK GU10



Series	Downlight
Lamp	GU10 MAX 50W
Color	Black
Material	Aluminum
Size	L 100 x W 100 x H 30

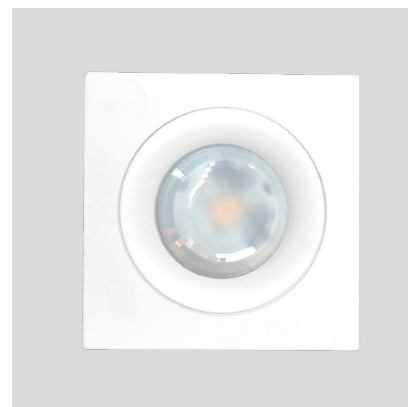

AK-748E-1 WH GU10 

Series	Downlight
Lamp	GU10 MAX 50W
Color	White
Material	Aluminum
Size	L 92 x W 92 x H 23



AK-748E-1 BK GU10 

Series	Downlight
Lamp	GU10 MAX 50W
Color	Black
Material	Aluminum
Size	L 92 x W 92 x H 23

AK-748E-2 WH 2XGU10 

Series	Downlight
Lamp	GU10 MAX 50W
Color	White
Material	Aluminum
Size	L 178 x W 92 x H 23



AK-748E-2 BK 2XGU10 

Series	Downlight
Lamp	GU10 MAX 50W
Color	Black
Material	Aluminum
Size	L 178 x W 92 x H 23



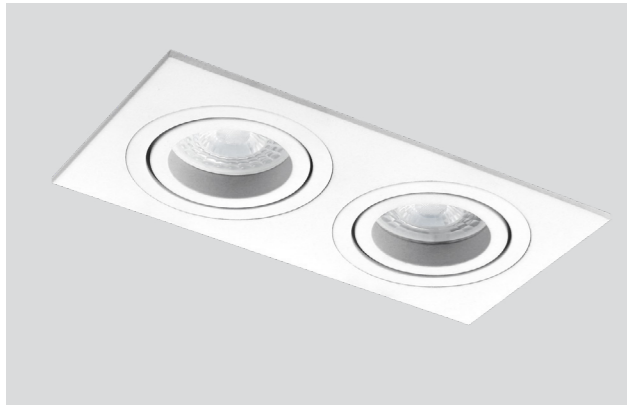

TH5813 WH 2XGU10 

Series	Downlight
Lamp	GU10 MAX 50W
Color	White
Material	Aluminum
Size	L 174 x W 90 x H 25



TH5813 BK 2XGU10 

Series	Downlight
Lamp	GU10 MAX 50W
Color	Black
Material	Aluminum
Size	L 174 x W 90 x H 25

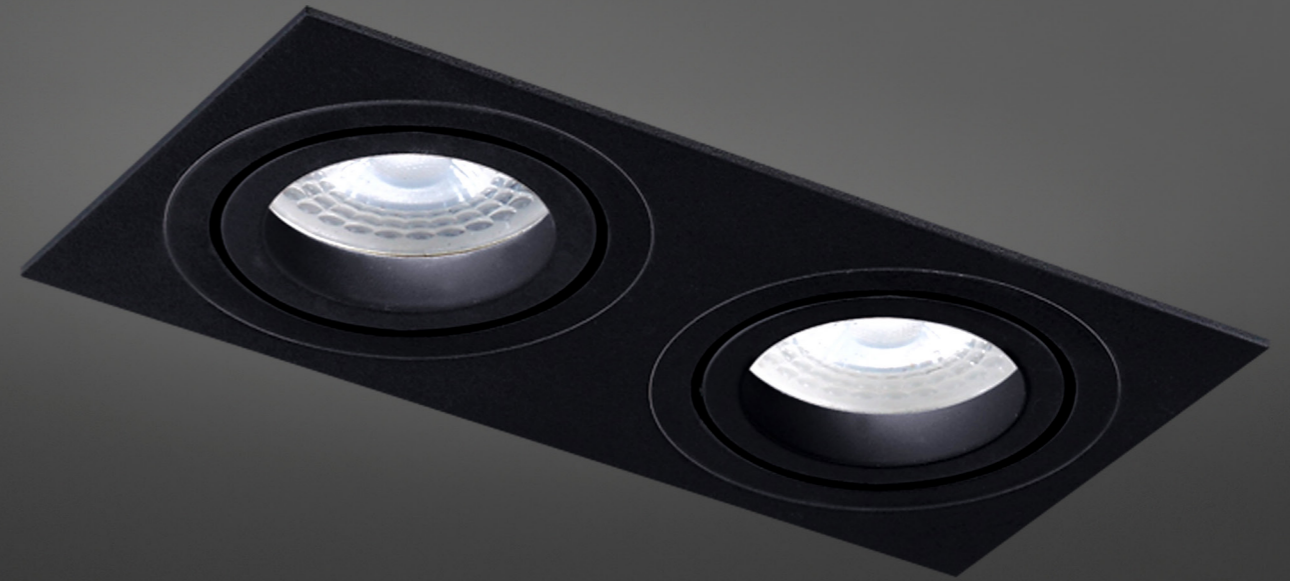



TH3532 WH 2xGU10



Series	Downlight
Lamp	GU10 MAX 50W
Color	White
Material	Aluminum
Size	L 185 x W 100 x H 30

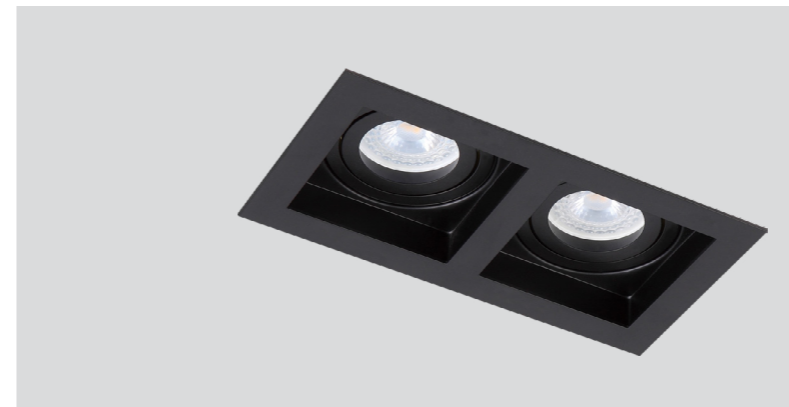

TH3532 BK 2xGU10



Series	Downlight
Lamp	GU10 MAX 50W
Color	Black
Material	Aluminum
Size	L 185 x W 100 x H 30



TH5829 WH GU10



Series	Tube Downlight
Lamp	GU10 MAX 50W
Color	White
Material	Aluminum
Size	D 65 x H 100



TH5829 BK GU10



Series	Tube Downlight
Lamp	GU10 MAX 50W
Color	Black
Material	Aluminum
Size	D 65 x H 100

TH5832 WH GU10



Series	Tube Downlight
Lamp	GU10 MAX 50W
Color	White
Material	Aluminum
Size	D 80 x H 105



TH5832 BK GU10



Series	Tube Downlight
Lamp	GU10 MAX 50W
Color	Black
Material	Aluminum
Size	D 80 x H 105



TH5827 WH GU10

Series	Tube Downlight
Lamp	GU10 MAX 50W
Color	White
Material	Aluminum
Size	D 80 x H 85

TH5827 BK GU10

Series	Tube Downlight
Lamp	GU10 MAX 50W
Color	Black
Material	Aluminum
Size	D 80 x H 85



TH5801 WH GU10

Series	Tube Downlight
Lamp	GU10 MAX 50W
Color	White
Material	Aluminum
Size	D 96 x H 125



TH5801 BK GU10

Series	Tube Downlight
Lamp	GU10 MAX 50W
Color	Black
Material	Aluminum
Size	D 96 x H 125



TH6802-200 WH GU10



Series	Tube Downlight
Lamp	GU10 MAX 50W
Color	White
Material	Aluminum
Size	D 70 x H 200



TH6802-300 WH GU10



Series	Tube Downlight
Lamp	GU10 MAX 50W
Color	White
Material	Aluminum
Size	D 70 x H 300



TH6802-200 BK GU10



Series	Tube Downlight
Lamp	GU10 MAX 50W
Color	Black
Material	Aluminum
Size	D 70 x H 200

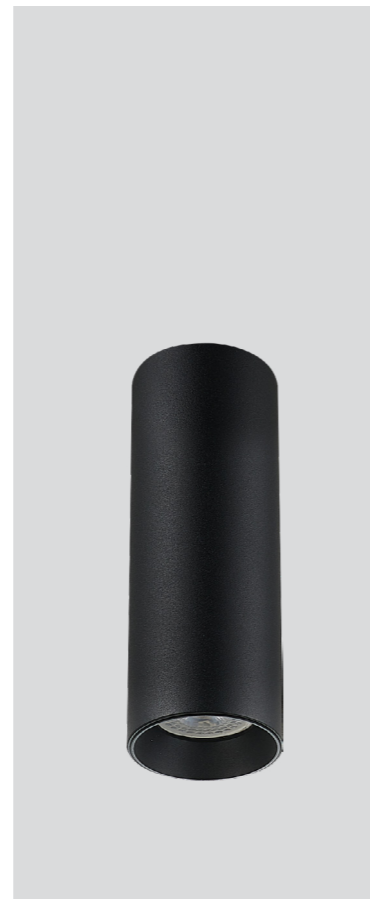

TH6802-300 BK GU10



Series	Tube Downlight
Lamp	GU10 MAX 50W
Color	Black
Material	Aluminum
Size	D 70 x H 300



TH6802-400 WH GU10



Series	Tube Downlight
Lamp	GU10 MAX 50W
Color	White
Material	Aluminum
Size	D 70 x H 400



TH6802-400 BK GU10



Series	Tube Downlight
Lamp	GU10 MAX 50W
Color	Black
Material	Aluminum
Size	D 70 x H 400





TH5802 WH GU10



Series	Tube Downlight
Lamp	GU10 MAX 50W
Color	White
Material	Aluminum
Size	L 97 x W 97 x H 125

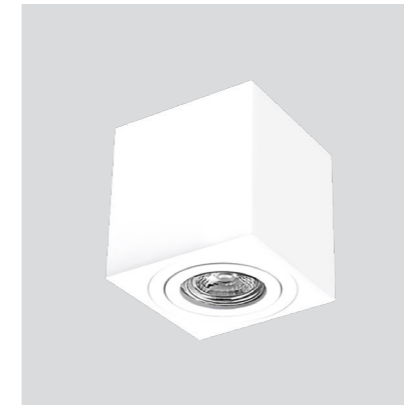

TH5828 WH GU10



Series	Tube Downlight
Lamp	GU10 MAX 50W
Color	White
Material	Aluminum
Size	L 80 x W 80 x H 85



TH5802 BK GU10



Series	Tube Downlight
Lamp	GU10 MAX 50W
Color	Black
Material	Aluminum
Size	L 97 x W 97 x H 125



TH5828 BK GU10



Series	Tube Downlight
Lamp	GU10 MAX 50W
Color	Black
Material	Aluminum
Size	L 80 x W 80 x H 85



TH6803-100 WH GU10 

Series	Tube Downlight
Lamp	GU10 MAX 50W
Color	White
Material	Aluminum
Size	L 56 x W 56 x H 100

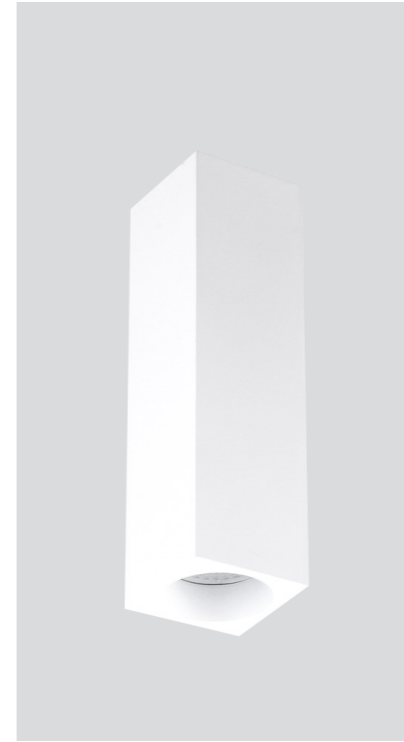

TH6803-200 WH GU10 

Series	Tube Downlight
Lamp	GU10 MAX 50W
Color	White
Material	Aluminum
Size	L 56 x W 56 x H 200



TH6803-100 BK GU10 

Series	Tube Downlight
Lamp	GU10 MAX 50W
Color	Black
Material	Aluminum
Size	L 56 x W 56 x H 100



TH6803-200 BK GU10 

Series	Tube Downlight
Lamp	GU10 MAX 50W
Color	Black
Material	Aluminum
Size	L 56 x W 56 x H 200

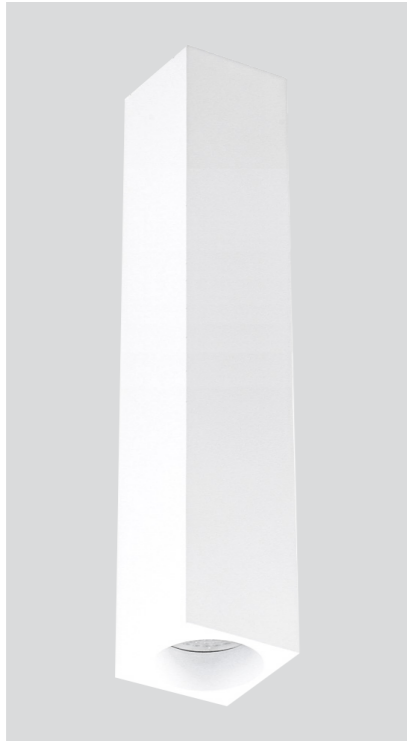

TH6803-300 WH GU10



Series	Tube Downlight
Lamp	GU10 MAX 50W
Color	White
Material	Aluminum
Size	L 56 x W 56 x H 300



TH6803-300 BK GU10



Series	Tube Downlight
Lamp	GU10 MAX 50W
Color	Black
Material	Aluminum
Size	L 56 x W 56 x H 300





DOWNLIGHTS

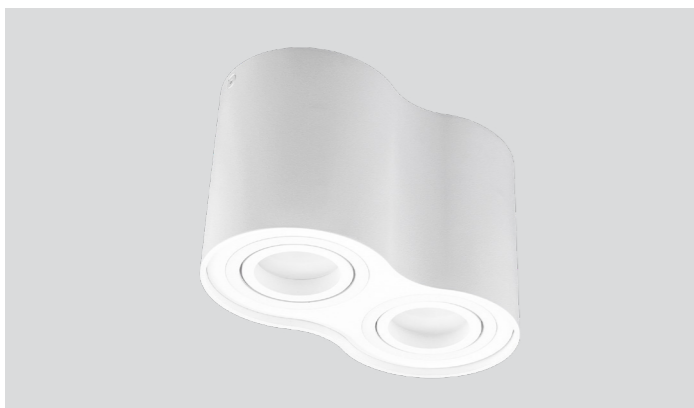

TH5803 WH 2XGU10



Series	Tube Downlight
Lamp	GU10 MAX 50W
Color	White
Material	Aluminum
Size	L 178 x D 96 x H 125



TH5834 WH 2XGU10



Series	Tube Downlight
Lamp	GU10 MAX 50W
Color	White
Material	Aluminum
Size	L 160 x D 80 x H 85



TH5803 BK 2XGU10



Series	Tube Downlight
Lamp	GU10 MAX 50W
Color	Black
Material	Aluminum
Size	L 178 x D 96 x H 125



TH5834 BK 2XGU10



Series	Tube Downlight
Lamp	GU10 MAX 50W
Color	Black
Material	Aluminum
Size	L 160 x D 80 x H 85



TH5804 WH 2XGU10



Series	Tube Downlight
Lamp	GU10 MAX 50W
Color	White
Material	Aluminum
Size	L 181 x W 96 x H 125



TH5835 WH 2XGU10



Series	Tube Downlight
Lamp	GU10 MAX 50W
Color	White
Material	Aluminum
Size	L 160 x W 80 x H 85



TH5804 BK 2XGU10



Series	Tube Downlight
Lamp	GU10 MAX 50W
Color	Black
Material	Aluminum
Size	L 181 x W 96 x H 125



TH5835 BK 2XGU10



Series	Tube Downlight
Lamp	GU10 MAX 50W
Color	Black
Material	Aluminum
Size	L 160 x W 80 x H 85

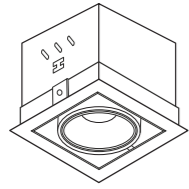

BX07-1-LED 7w WH  

Series	Downlight
LED	COB
CCT	3000K/4000K
CRI	RA ≥ 80
Power	7w
Luminous Flux	525 Lm
Beam Angle	24°
Color	White
Material	Aluminum
Size	L 122 x W 122 x H 70

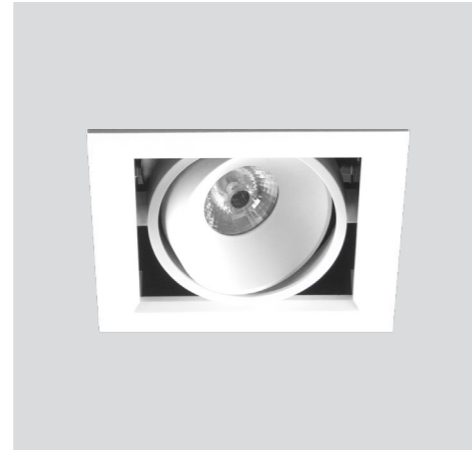

BX07-1-LED 7w BK  

Series	Downlight
LED	COB
CCT	3000K/4000K
CRI	RA ≥ 80
Power	7w
Luminous Flux	525 Lm
Beam Angle	24°
Color	Black
Material	Aluminum
Size	L 122 x W 122 x H 70



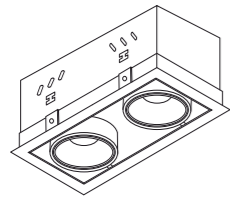

BX07-2-LED 2x7W WH   

Series	Downlight
LED	COB
CCT	3000K/4000K
CRI	RA ≥ 80
Power	7w
Luminous Flux	2 x 525 Lm
Beam Angle	24°
Color	White
Material	Aluminum
Size	L 225 x W 122 x H 70

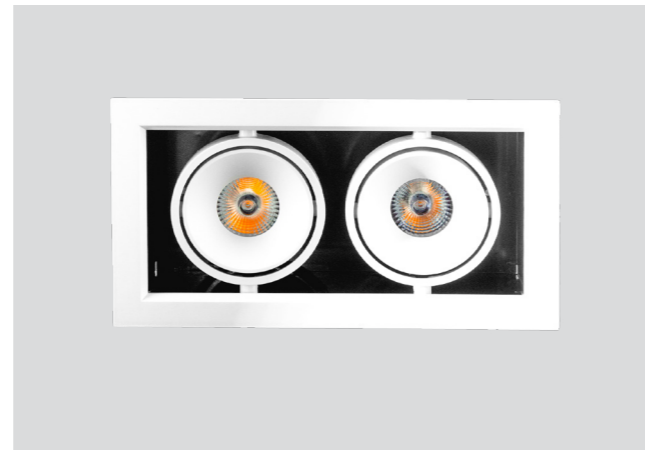

BX07-2-LED 2x7W BK   

Series	Downlight
LED	COB
CCT	3000K/4000K
CRI	RA ≥ 80
Power	7w
Luminous Flux	2 x 525 Lm
Beam Angle	24°
Color	Black
Material	Aluminum
Size	L 225 x W 122 x H 70

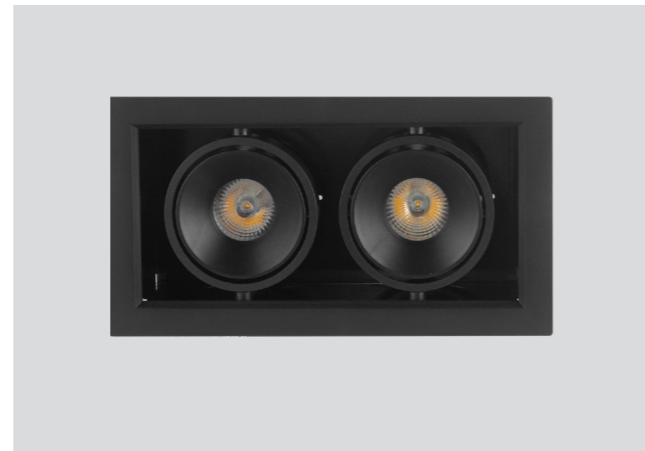

XT4550-1-LED 1,5w WH 

Series	Downlight
LED	COB
CCT	3000K/6000K
CRI	RA ≥ 80
Power	1,5w
Luminous Flux	120 Lm
Beam Angle	24°
Color	White
Material	Aluminum
Size	L 45 x W 45 x H 48

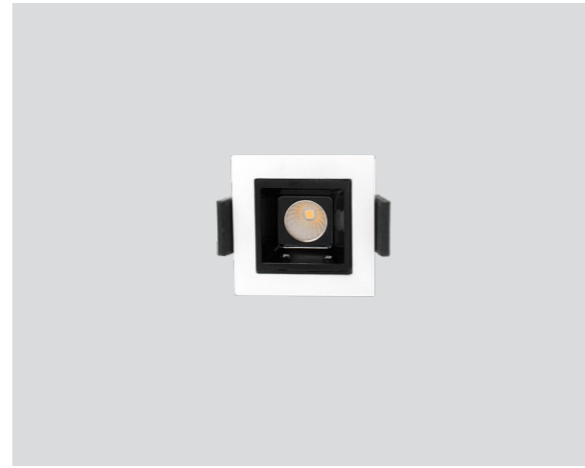
**XT4550-2-LED 3w WH** 

Series	Downlight
LED	COB
CCT	3000K/6000K
CRI	RA ≥ 80
Power	3w
Luminous Flux	240 Lm
Beam Angle	24°
Color	White
Material	Aluminum
Size	L 75 x W 45 x H 48

**XT4550-3-LED 5w WH** 

Series	Downlight
LED	COB
CCT	3000K/6000K
CRI	RA ≥ 80
Power	5w
Luminous Flux	400 Lm
Beam Angle	24°
Color	White
Material	Aluminum
Size	L 105 x W 45 x H 48



XT4550-5-LED 8w WH

Series	Downlight
LED	COB
CCT	3000K/6000K
CRI	RA ≥ 80
Power	8w
Luminous Flux	640 Lm
Beam Angle	24°
Color	White
Material	Aluminum
Size	L 145 x W 45 x H 48

XT4550-10-LED 12w WH

Series	Downlight
LED	COB
CCT	3000K/6000K
CRI	RA ≥ 80
Power	12w
Luminous Flux	960 Lm
Beam Angle	24°
Color	White
Material	Aluminum
Size	L 280 x W 45 x H 48

XT4550-15-LED 18w WH

Series	Downlight
LED	COB
CCT	3000K/6000K
CRI	RA ≥ 80
Power	18w
Luminous Flux	1440 Lm
Beam Angle	24°
Color	White
Material	Aluminum
Size	L 413 x W 45 x H 48

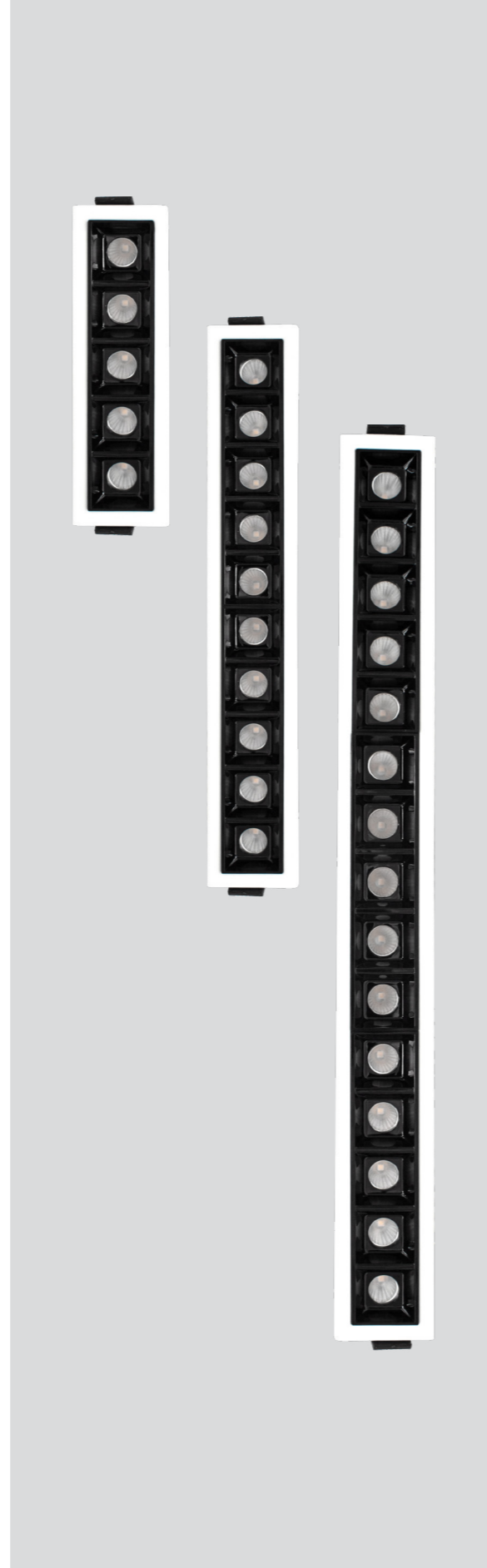



● **Pendant lights**
series

ПОДВЕСНЫЕ СВЕТИЛЬНИКИ

отличное решение, которое можно использовать как основное либо акцентное освещение. Серия светильников такого типа создана для применения в сфере интерьерной подсветки жилых и торговых помещений, выставочных залов, ресторанов, кафе, галерей и тд.

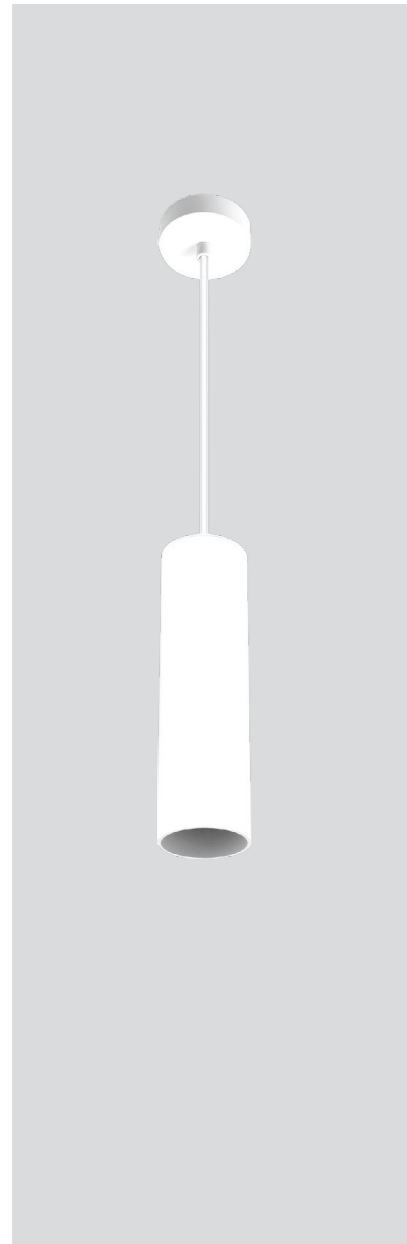

PD6801-200 WH GU10 

Series	Pendant lights
Lamp	GU10 MAX 50W
Color	White
Material	Aluminum
Size	D 56 x H1 200 x H 1340



PD6801-200 BK GU10 

Series	Pendant lights
Lamp	GU10 MAX 50W
Color	Black
Material	Aluminum
Size	D 56 x H1 200 x H 1340

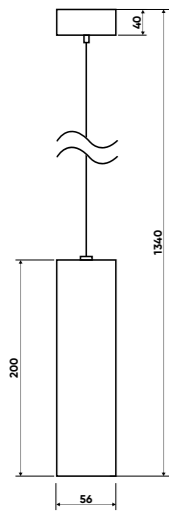

PD6801-300 WH GU10 

Series	Pendant lights
Lamp	GU10 MAX 50W
Color	White
Material	Aluminum
Size	D 56 x H1 300 x H 1440



PD6801-300 BK GU10 

Series	Pendant lights
Lamp	GU10 MAX 50W
Color	Black
Material	Aluminum
Size	D 56 x H1 300 x H 1440

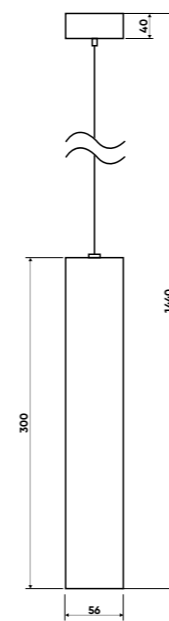



PD6801-400 WH GU10 

Series	Pendant lights
Lamp	GU10 MAX 50W
Color	White
Material	Aluminum
Size	D 56 x H 400



PD6801-400 BK GU10 

Series	Pendant lights
Lamp	GU10 MAX 50W
Color	Black
Material	Aluminum
Size	D 56 x H1 400 x H 1540

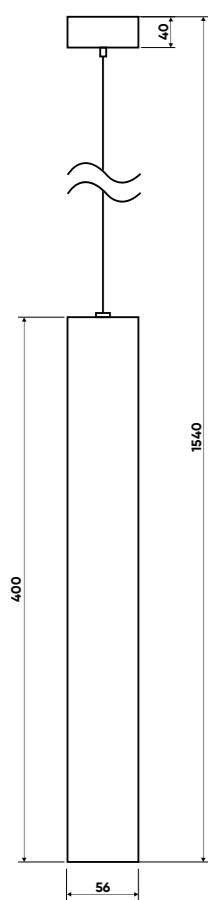

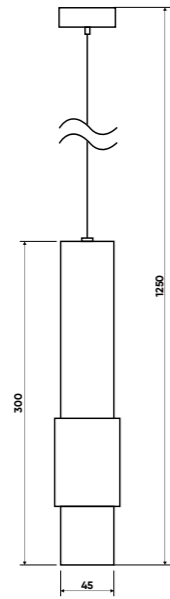

DX523A-COB 7w WH 

Series	Pendant lights
LED	COB
CCT	3000K/4000K
CRI	RA ≥ 80
Power	7w
Luminous Flux	500 Lm
Beam Angle	24°
Color	White
Material	Aluminum
Size	D 45 x H1 300 x H 1250



DX523A-COB 7w BK 

Series	Pendant lights
LED	COB
CCT	3000K/4000K
CRI	RA ≥ 80
Power	7w
Luminous Flux	500 Lm
Beam Angle	24°
Color	Black
Material	Aluminum
Size	D 45 x H1 300 x H 1250

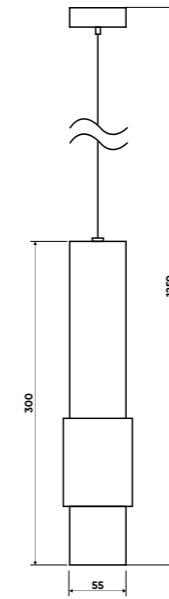

DX523B-COB 7w WH 

Series	Pendant lights
LED	COB
CCT	3000K/4000K
CRI	RA ≥ 80
Power	7w
Luminous Flux	500 Lm
Beam Angle	24°
Color	White
Material	Aluminum
Size	D 55 x H1 300 x H 1250



DX523B-COB 7w BK 

Series	Pendant lights
LED	COB
CCT	3000K/4000K
CRI	RA ≥ 80
Power	7w
Luminous Flux	500 Lm
Beam Angle	24°
Color	Black
Material	Aluminum
Size	D 55 x H1 300 x H 1250



XT3312A-LED 30W WH



Series	Pendant lights
LED	COB
CCT	3000K/ 4000K
CRI	RA ≥ 80
Power	30w
Luminous Flux	2400 Lm
Beam Angle	170 °
Color	White
Material	Aluminum
Size	L 1200 x W 34 x H1 67 x H 1000



XT4312A-LED 40W WH



Series	Pendant lights
LED	COB
CCT	3000K/ 4000K
CRI	RA ≥ 80
Power	40w
Luminous Flux	2400 Lm
Beam Angle	170 °
Color	White
Material	Aluminum
Size	L 1200 x W 44 x H1 67 x H 1000



XT3312B-LED 40W WH



Series	Pendant lights
LED	COB
CCT	3000K/ 4000K
CRI	RA ≥ 80
Power	40w
Luminous Flux	3200 Lm
Beam Angle	170 ° + 15/30 °
Color	White
Material	Aluminum
Size	L 1200 x W 34 x H1 67 x H 1000



XT4312B-LED 40W WH



Series	Pendant lights
LED	COB
CCT	3000K/ 4000K
CRI	RA ≥ 80
Power	40w
Luminous Flux	3200 Lm
Beam Angle	170 ° + 15/30 °
Color	White
Material	Aluminum
Size	L 1200 x W 44 x H1 67 x H 1000



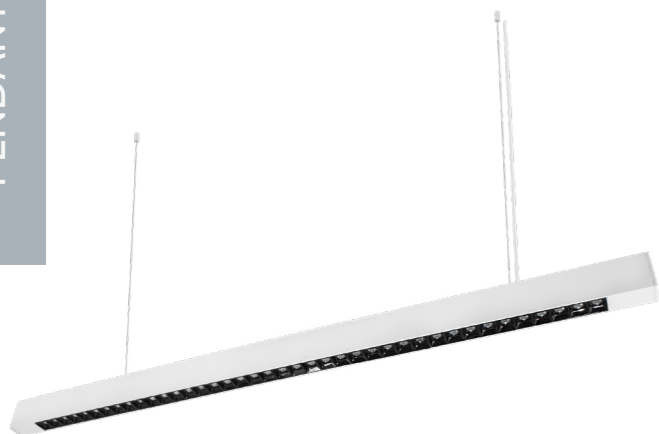

XT3312C-LED 40w WH

Series	Pendant lights
LED	COB
CCT	3000K/ 4000K
CRI	RA ≥ 80
Power	40w
Luminous Flux	3200 Lm
Beam Angle	170 °
Color	White
Material	Aluminum
Size	L 1200 x W 34 x H1 67 x H 1000



XT4312C-LED 40w WH

Series	Pendant lights
LED	COB
CCT	3000K/ 4000K
CRI	RA ≥ 80
Power	40w
Luminous Flux	3200 Lm
Beam Angle	170 °
Color	White
Material	Aluminum
Size	L 1200 x W 44 x H1 67 x H 1000

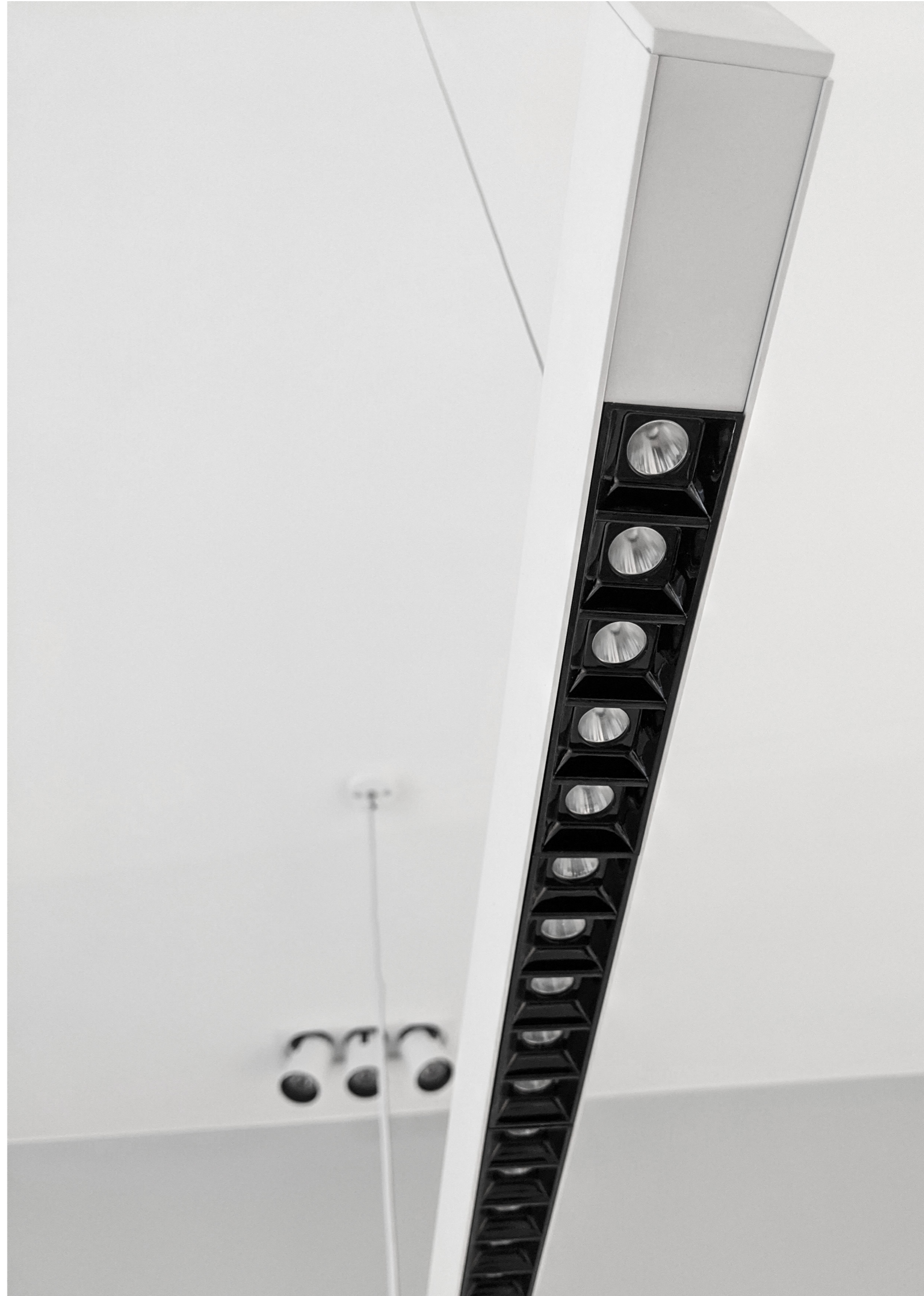

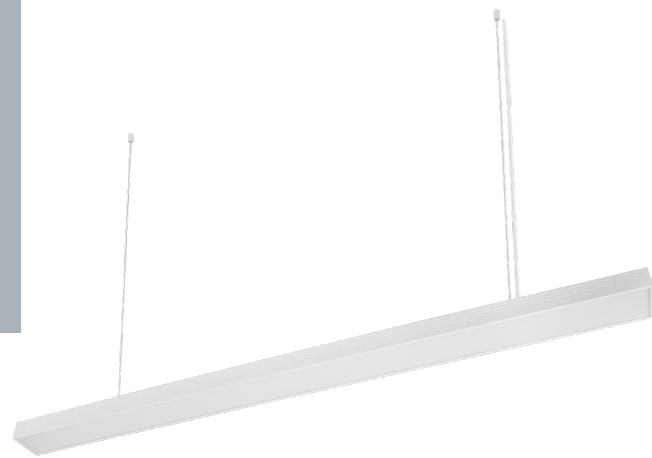

DG0712-LED 36W WH

Series	Pendant lights
LED	COB
CCT	6000K
CRI	RA ≥ 80
Power	36w
Luminous Flux	2880 Lm
Beam Angle	165°
Color	White
Material	Aluminum
Size	L 1200 x W 100 x H1 50 x H 1000

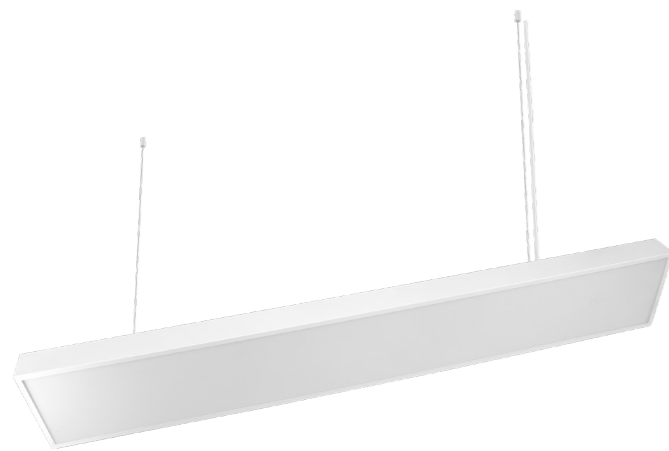

DG1812-LED 36W WH

Series	Pendant lights
LED	COB
CCT	6000K
CRI	RA ≥ 80
Power	36w
Luminous Flux	2880 Lm
Beam Angle	165°
Color	White
Material	Steel
Size	L 1200 x W 180 x H1 50 x H 1000

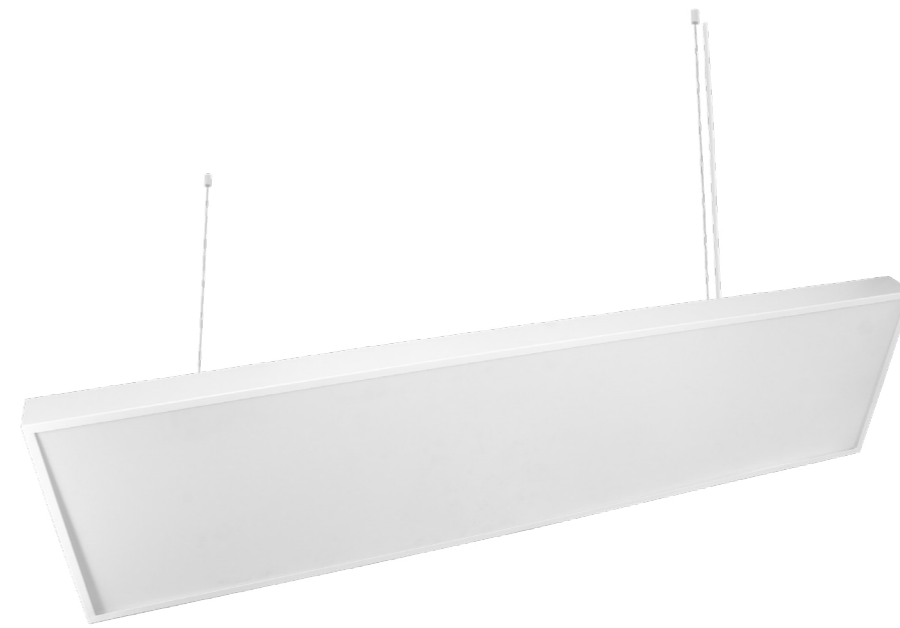

DG3012-LED 72W WH

Series	Pendant lights
LED	COB
CCT	6000K
CRI	RA ≥ 80
Power	72w
Luminous Flux	3840 Lm
Beam Angle	165°
Color	White
Material	Steel
Size	L 1200 x W 295 x H1 50 x H 1000



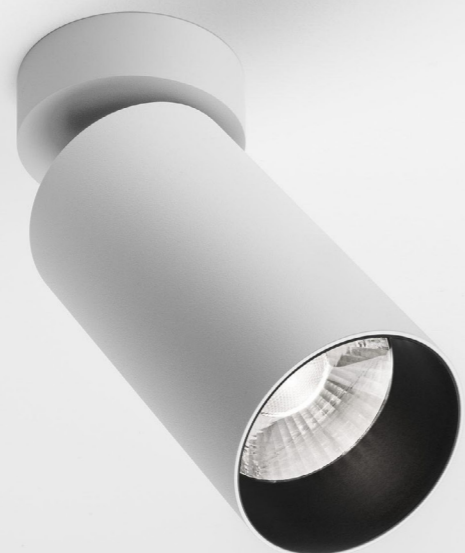

• Spotlights

series

СПОТЫ

создают как равномерное, так и зональное освещение. Угол наклона светильника способен обеспечить узконаправленный свет, который помогает акцентировать внимание на конкретном предмете интерьера.

TH5840 WH GU10

Series	Spotlight
Lamp	GU10 MAX 50W
Color	White
Material	Aluminum
Size	D 56 x H 140

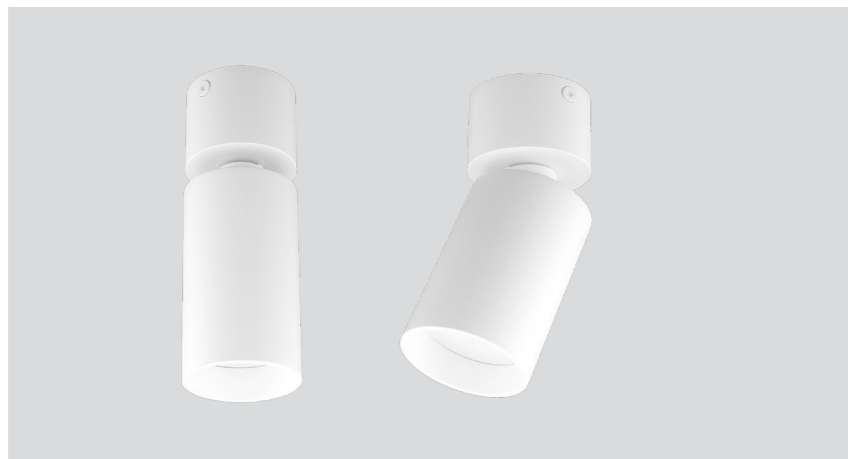
**TH5840 BK GU10**

Series	Spotlight
Lamp	GU10 MAX 50W
Color	Black
Material	Aluminum
Size	D 56 x H 140



D208A-COB 7W WH

Series	Spotlight
LED	COB
CCT	3000K/4000K
CRI	RA ≥ 80
Power	7w
Luminous Flux	525 Lm
Beam Angle	24 °
Color	White
Material	Aluminum
Size	D 45 x H 175 x L 140

**D208A-COB 7W WH+BK**

Series	Spotlight
LED	COB
CCT	3000K/4000K
CRI	RA ≥ 80
Power	7w
Luminous Flux	525 Lm
Beam Angle	24 °
Color	White+Black
Material	Aluminum
Size	D 45 x H 175 x L 140

**D208A-COB 7W BK**

Series	Spotlight
LED	COB
CCT	3000K/4000K
CRI	RA ≥ 80
Power	7w
Luminous Flux	525 Lm
Beam Angle	24 °
Color	Black
Material	Aluminum
Size	D 45 x H 175 x L 140

**D208B-COB 12W WH**

Series	Spotlight
LED	COB
CCT	3000K/4000K
CRI	RA ≥ 80
Power	12w
Luminous Flux	900 Lm
Beam Angle	24 °
Color	White
Material	Aluminum
Size	D 55 x L 140 x H 173

**D208B-COB 12W BK**

Series	Spotlight
LED	COB
CCT	3000K/4000K
CRI	RA ≥ 80
Power	12w
Luminous Flux	900 Lm
Beam Angle	24 °
Color	Black
Material	Aluminum
Size	D 55 x L 140 x H 173



D209A-COB 7W WH

Series	Spotlight
LED	COB
CCT	3000K/4000K
CRI	RA ≥ 80
Power	7w
Luminous Flux	500 Lm
Beam Angle	24°
Color	White
Material	Aluminum
Size	D 55 x L 91 x H 126

**D209A-COB 7W BK**

Series	Spotlight
LED	COB
CCT	3000K/4000K
CRI	RA ≥ 80
Power	7w
Luminous Flux	500 Lm
Beam Angle	24°
Color	Black
Material	Aluminum
Size	D 55 x L 91 x H 126



D209B-COB 12W WH

Series	Spotlight
LED	COB
CCT	3000K/4000K
CRI	RA ≥ 80
Power	12w
Luminous Flux	900 Lm
Beam Angle	24 °
Color	White
Material	Aluminum
Size	D 65 x L 110 x H 145

**D209BL-COB 18W WH+BK**

Series	Spotlight
LED	COB
CCT	3000K/4000K
CRI	RA ≥ 80
Power	18w
Luminous Flux	1350 Lm
Beam Angle	24 °
Color	White+Black
Material	Aluminum
Size	D 65 x H 220 x L 180

**D209B-COB 12W BK**

Series	Spotlight
LED	COB
CCT	3000K/4000K
CRI	RA ≥ 80
Power	12w
Luminous Flux	900 Lm
Beam Angle	24 °
Color	Black
Material	Aluminum
Size	D 65 x L 110 x H 145

**D209BL-COB 18W BK**

Series	Spotlight
LED	COB
CCT	3000K/4000K
CRI	RA ≥ 80
Power	18w
Luminous Flux	1350 Lm
Beam Angle	24 °
Color	Black
Material	Aluminum
Size	D 65 x H 220 x L 180



TH8801 WH GU10

Series	Spotlight
Lamp	GU10 MAX 50W
Color	White
Material	Aluminum
Size	L 110 x W 70 x H 105

**TH8801 BK GU10**

Series	Spotlight
Lamp	GU10 MAX 50W
Color	Black
Material	Aluminum
Size	L 110 x W 70 x H 105

**TH8802 WH 2XGU10**

Series	Spotlight
Lamp	GU10 MAX 50W
Color	White
Material	Aluminum
Size	L 220 x W 70 x H 105

**TH8802 BK 2XGU10**

Series	Spotlight
Lamp	GU10 MAX 50W
Color	Black
Material	Aluminum
Size	L 220 x W 70 x H 105



TH8803 WH 3XGU10

Series	Spotlight
Lamp	GU10 MAX 50W
Color	White
Material	Aluminum
Size	L 350 x W 70 x H 103

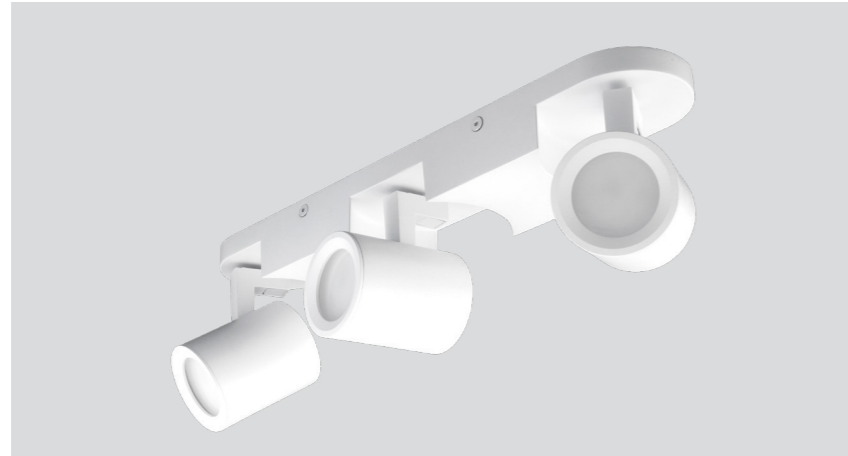
**TH8803 BK 3XGU10**

Series	Spotlight
Lamp	GU10 MAX 50W
Color	Black
Material	Aluminum
Size	L 350 x W 70 x H 103



TH8901 WH GU10

Series	Spotlight
Lamp	GU10 MAX 50W
Color	White
Material	Aluminum
Size	L 120 x W 60 x H 120

**TH8901 BK GU10**

Series	Spotlight
Lamp	GU10 MAX 50W
Color	Black
Material	Aluminum
Size	L 120 x W 60 x H 120

**TH8902 WH 2XGU10**

Series	Spotlight
Lamp	GU10 MAX 50W
Color	White
Material	Aluminum
Size	L 250 x W 60 x H 120

**TH8902 BK 2XGU10**

Series	Spotlight
Lamp	GU10 MAX 50W
Color	Black
Material	Aluminum
Size	L 250 x W 60 x H 120





Track lights

series

ТРЕКОВЫЕ СВЕТИЛЬНИКИ

крепятся вертикально либо горизонтально на специальном шинопроводе. Высокий функционал и мобильность поворотного механизма светильника открывают огромный спектр возможностей создания любых сценариев освещения.



TR8801 WH GU10



Series	Track lights
Lamp	GU10 MAX 50W
Color	White
Material	Aluminum
Size	D 58 x H 120



TR5840-L WH GU10



Series	Track lights
Lamp	GU10 MAX 50W
Color	White
Material	Aluminum
Size	D 56 x H 180



TR8801 BK GU10



Series	Track lights
Lamp	GU10 MAX 50W
Color	Black
Material	Aluminum
Size	D 58 x H 120



TR5840-L BK GU10



Series	Track lights
Lamp	GU10 MAX 50W
Color	Black
Material	Aluminum
Size	D 56 x H 180





H6204A-COB 7W WH+BK  

Series	Track lights
LED	COB
CCT	3000K/4000K
CRI	RA ≥ 80
Power	7w
Luminous Flux	525 Lm
Beam Angle	24 °
Color	White+Black
Material	Aluminum
Size	D 55 x H 135 x L 90



H6204A-COB 7W BK  

Series	Track lights
LED	COB
CCT	3000K/4000K
CRI	RA ≥ 80
Power	7w
Luminous Flux	525 Lm
Beam Angle	24 °
Color	Black
Material	Aluminum
Size	D 55 x H 135 x L 90





H208A-COB 7W WH



Series	Track lights
LED	COB
CCT	3000K/4000K
CRI	RA ≥ 80
Power	7w
Luminous Flux	500 Lm
Beam Angle	24 °
Color	White
Material	Aluminum
Size	D 45 x H 180 x L 140



H208A-COB 7W BK



Series	Track lights
LED	COB
CCT	3000K/4000K
CRI	RA ≥ 80
Power	7w
Luminous Flux	500 Lm
Beam Angle	24 °
Color	Black
Material	Aluminum
Size	D 45 x H 180 x L 140





H208B-COB 12w WH  

Series	Track lights
LED	COB
CCT	3000K/4000K
CRI	RA ≥ 80
Power	12w
Luminous Flux	900 Lm
Beam Angle	24 °
Color	White
Material	Aluminum
Size	D 55 x H 180 x L 140



H208B-COB 12w BK  

Series	Track lights
LED	COB
CCT	3000K/4000K
CRI	RA ≥ 80
Power	12w
Luminous Flux	900 Lm
Beam Angle	24 °
Color	Black
Material	Aluminum
Size	D 55 x H 180 x L 140

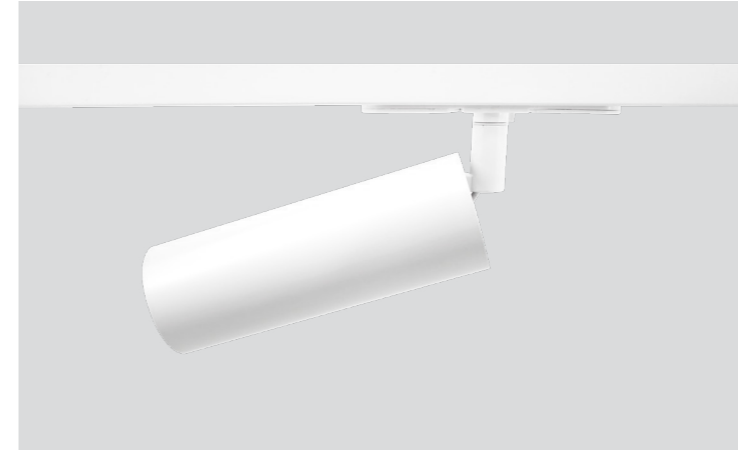

H208C-COB 18w WH  

Series	Track lights
LED	COB
CCT	3000K/4000K
CRI	RA ≥ 80
Power	18w
Luminous Flux	1350 Lm
Beam Angle	24 °
Color	White
Material	Aluminum
Size	D 65 x H 225 x L 178



H208C-COB 18w BK  

Series	Track lights
LED	COB
CCT	3000K/4000K
CRI	RA ≥ 80
Power	18w
Luminous Flux	1350 Lm
Beam Angle	24 °
Color	Black
Material	Aluminum
Size	D 65 x H 225 x L 178



H209A-COB 7W WH 

Series	Track lights
LED	COB
CCT	3000K/4000K
CRI	RA ≥ 80
Power	7w
Luminous Flux	500 Lm
Beam Angle	24 °
Color	White
Material	Aluminum
Size	D 55 x H 138 x L 90



H209A-COB 12W WH 

Series	Track lights
LED	COB
CCT	3000K/4000K
CRI	RA ≥ 80
Power	12w
Luminous Flux	900 Lm
Beam Angle	24 °
Color	White
Material	Aluminum
Size	D 55 x H 138 x L 90



H209A-COB 7W BK 

Series	Track lights
LED	COB
CCT	3000K/4000K
CRI	RA ≥ 80
Power	7w
Luminous Flux	500 Lm
Beam Angle	24 °
Color	Black
Material	Aluminum
Size	D 55 x H 138 x L 90



H209A-COB 12W BK 

Series	Track lights
LED	COB
CCT	3000K/4000K
CRI	RA ≥ 80
Power	12w
Luminous Flux	900 Lm
Beam Angle	24 °
Color	Black
Material	Aluminum
Size	D 55 x H 138 x L 90



H209AL-COB 12w WH  

Series	Track lights
LED	COB
CCT	3000K/4000K
CRI	RA ≥ 80
Power	12w
Luminous Flux	900 Lm
Beam Angle	24 °
Color	White
Material	Aluminum
Size	D 55 x H 190 x L 140



H209AL-COB 12w BK  

Series	Track lights
LED	COB
CCT	3000K/4000K
CRI	RA ≥ 80
Power	12w
Luminous Flux	900 Lm
Beam Angle	24 °
Color	Black
Material	Aluminum
Size	D 55 x H 190 x L 140



H209B-COB 12w WH  

Series	Track lights
LED	COB
CCT	3000K/4000K
CRI	RA ≥ 80
Power	12w
Luminous Flux	900 Lm
Beam Angle	24 °
Color	White
Material	Aluminum
Size	D 65 x H 158 x L 110



H209B-COB 12w BK  

Series	Track lights
LED	COB
CCT	3000K/4000K
CRI	RA ≥ 80
Power	12w
Luminous Flux	900 Lm
Beam Angle	24 °
Color	Black
Material	Aluminum
Size	D 65 x H 158 x L 110



H209B-COB 18w WH+BK



Series	Track lights
LED	COB
CCT	3000K/4000K
CRI	RA ≥ 80
Power	18w
Luminous Flux	1350 Lm
Beam Angle	24°
Color	White+Black
Material	Aluminum
Size	D 65 x H 158 x L 110

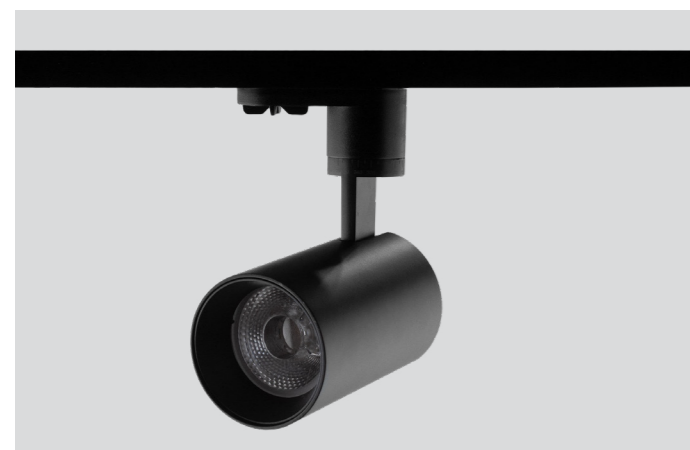

H209B-COB 18w BK



Series	Track lights
LED	COB
CCT	3000K/4000K
CRI	RA ≥ 80
Power	18w
Luminous Flux	1350 Lm
Beam Angle	24°
Color	Black
Material	Aluminum
Size	D 65 x H 158 x L 110



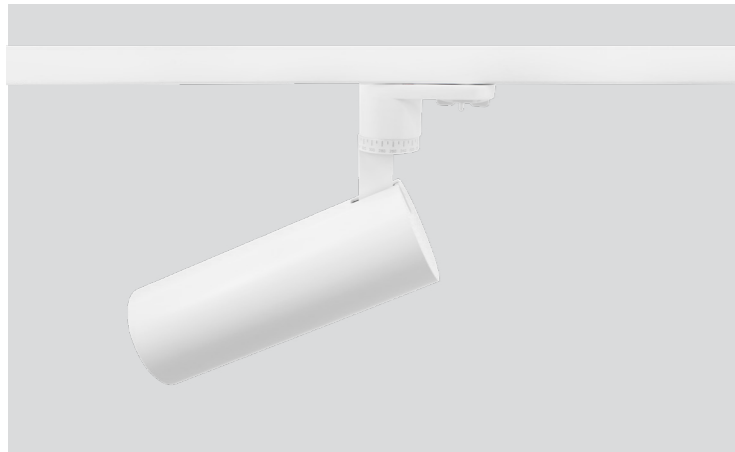

H209BL-COB 18W WH  

Series	Track lights
LED	COB
CCT	3000K/4000K
CRI	RA ≥ 80
Power	18w
Luminous Flux	1350 Lm
Beam Angle	24 °
Color	White
Material	Aluminum
Size	D 65 x H 230 x L 180



H209BL-COB 18W BK  

Series	Track lights
LED	COB
CCT	3000K/4000K
CRI	RA ≥ 80
Power	18w
Luminous Flux	1350 Lm
Beam Angle	24 °
Color	Black
Material	Aluminum
Size	D 65 x H 230 x L 180



H209C-COB 18W WH  

Series	Track lights
LED	COB
CCT	3000K/4000K
CRI	RA ≥ 80
Power	18w
Luminous Flux	1350 Lm
Beam Angle	24 °
Color	White
Material	Aluminum
Size	D 75 x H 190 x L 130



H209C-COB 18W BK  

Series	Track lights
LED	COB
CCT	3000K/4000K
CRI	RA ≥ 80
Power	18w
Luminous Flux	1350 Lm
Beam Angle	24 °
Color	Black
Material	Aluminum
Size	D 75 x H 190 x L 130

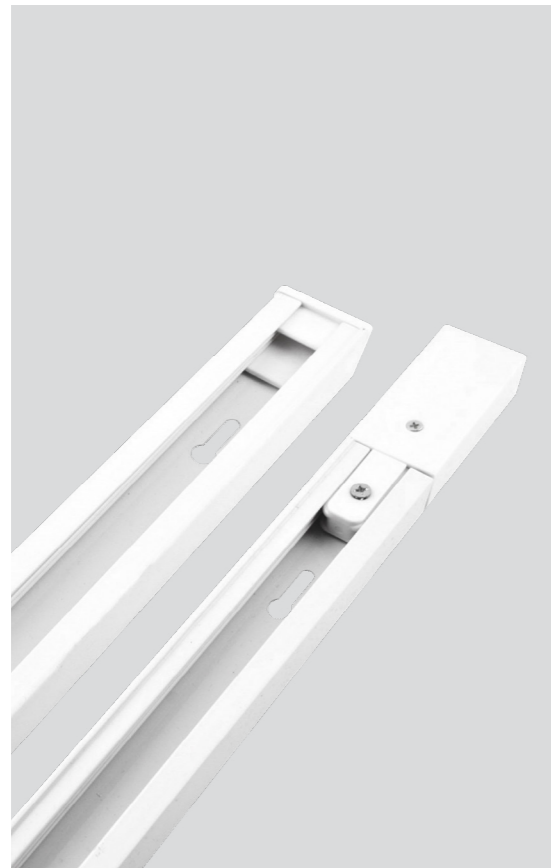

1-PHASE TRACK

STR-10-1 WH

Series	Track profile
Color	White
Material	Aluminum
Size	L 100 x W 35

STR-15-1 WH

Series	Track profile
Color	White
Material	Aluminum
Size	L 150 x W 35

STR-20-1 WH

Series	Track profile
Color	White
Material	Aluminum
Size	L 200 x W 35

STR-10-11 BK

Series	Track profile
Color	Black
Material	Aluminum
Size	L 100 x W 35

STR-15-11 BK

Series	Track profile
Color	Black
Material	Aluminum
Size	L 150 x W 35

STR-20-11 BK

Series	Track profile
Color	Black
Material	Aluminum
Size	L 200 x W 35



TRACK CONNECTORS



STR-2101-1 WH

Series	I-connector
Color	White
Material	Plastic / Metal
Size	L 105 x W 30



STR-2101-11 BK

Series	I-connector
Color	Black
Material	Plastic / Metal
Size	L 105 x W 30



STR-2102-1 WH

Series	L-connector
Color	White
Material	Plastic / Metal
Size	L 70 x W 70



STR-2102-11 BK

Series	L-connector
Color	Black
Material	Plastic / Metal
Size	L 70 x W 70



STR-2103-1 WH

Series	T-connector
Color	White
Material	Plastic / Metal
Size	L 105 x W 70



STR-2103-11 BK

Series	T-connector
Color	Black
Material	Plastic / Metal
Size	L 105 x W 70

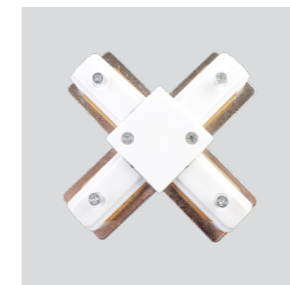

STR-2104-1 WH

Series	X-connector
Color	White
Material	Plastic / Metal
Size	L 105 x W 105



STR-2104-11 BK

Series	X-connector
Color	Black
Material	Plastic / Metal
Size	L 105 x W 105

CABLE SYSTEMS FOR HANGING TRACK



STR-2105-1

Series	Cable systems
Color	White
Material	Aluminum
Size	L 1000 x D 50



STR-2105-11

Series	Cable systems
Color	Black
Material	Aluminum
Size	L 1000 x D 50



H208A GD

Series	Track rings
Color	Gold
Material	Plastic
Size	D 45



съемные кольца на модели H208A, D208A

H208A CH

Series	Track rings
Color	Chrome
Material	Plastic
Size	D 45

H208B GD

Series	Track rings
Color	Gold
Material	Plastic
Size	D 55



съемные кольца на модели D208B, H208B, D209A, H209A, H209AL, H6204A

H208B CH

Series	Track rings
Color	Chrome
Material	Plastic
Size	D 55

H208B GD

Series	Track rings
Color	Gold
Material	Plastic
Size	D 65



съемные кольца на модели H208C, D209B, H209B, D209BL, H209BL

H208B CH

Series	Track rings
Color	Chrome
Material	Plastic
Size	D 65





—● **Wall lights**
series

НАСТЕННЫЕ СВЕТИЛЬНИКИ

могут являться как декоративным элементом или основным светом, так и применяться для акцентирования внимания на предмете интерьера. Серия светильников отличается лаконичностью, геометрией форм, высококачественным внутренним наполнением и высоким функционалом.



WL1604 WH 2XGU10 

Series	Wall lights
Lamp	GU10 MAX 50W
Color	White
Material	Aluminum
Size	W 75 x D 56 x H 180



WL1604 BK 2XGU10 

Series	Wall lights
Lamp	GU10 MAX 50W
Color	Black
Material	Aluminum
Size	W 75 x D 56 x H 180





WL1606 WH 2XGU10 

Series	Wall lights
Lamp	GU10 MAX 50W
Color	White
Material	Aluminum
Size	W 75 x D 70 x H 180



WL1608 WH 2XGU10 

Series	Wall lights
Lamp	GU10 MAX 50W
Color	White
Material	Aluminum
Size	W 75 x D 75 x H 220



WL1606 BK 2XGU10 

Series	Wall lights
Lamp	GU10 MAX 50W
Color	Black
Material	Aluminum
Size	W 75 x D 70 x H 180



WL1608 BK 2XGU10 

Series	Wall lights
Lamp	GU10 MAX 50W
Color	Black
Material	Aluminum
Size	W 75 x D 75 x H 220



AK-732C-COB 3W WH

Series	Downlight
LED	COB
CCT	3000K
CRI	RA ≥ 80
Power	3w
Luminous Flux	240 Lm
Beam Angle	24 °
Color	White
Material	Aluminum
Size	D 48 x H 30

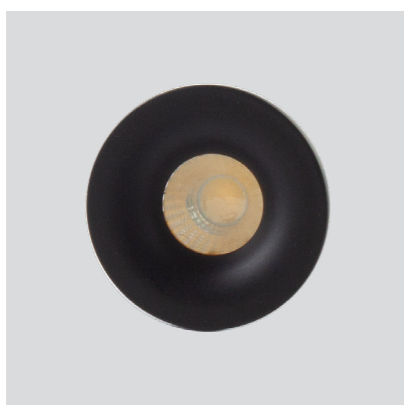

AK-732C-COB 3W BK

Series	Downlight
LED	COB
CCT	3000K
CRI	RA ≥ 80
Power	3w
Luminous Flux	240 Lm
Beam Angle	24 °
Color	Black
Material	Aluminum
Size	D 48 x H 30





• Outdoor lighting

УЛИЧНОЕ ОСВЕЩЕНИЕ

идеальный вариант локального освещения, который предназначен для размещения на открытом воздухе. Серия светильников наполнена самыми разнообразными моделями, что позволяет создавать эстетичные и высокотехнологичные сценарии освещения.



OLP007-2815-COB 7W BK

Series	Outdoor
LED	COB
CCT	3000K
CRI	RA ≥ 70
Power	7w
Luminous Flux	420 Lm
Beam Angle	120 °
Color	Graphite
Material	Aluminum
Size	D 50 x H 130





OLP2207-COB 3W BK

Series	Outdoor
LED	COB
CCT	3000K
CRI	RA ≥ 80
Power	1x3w
Luminous Flux	180 Lm
Beam Angle	120 °
Color	Satin
Material	Steel
Size	D 51 x H 82



Схема монтажа



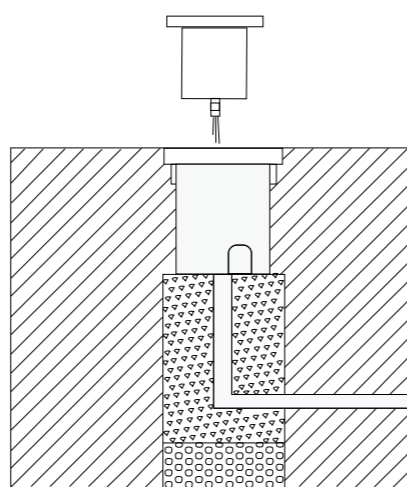
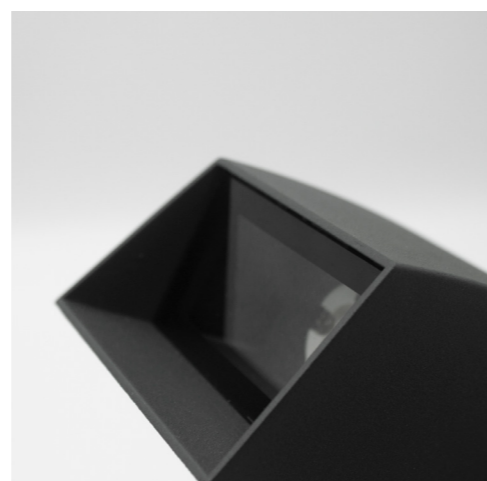

OLP2209-COB 1W+3W BK

Series	Outdoor wall light
LED	COB
CCT	3000K
CRI	RA ≥ 80
Power	1w+3w
Luminous Flux	240 Lm
Beam Angle	120 °
Color	Graphite
Material	Aluminum
Size	H 170 x L 80 x W 47



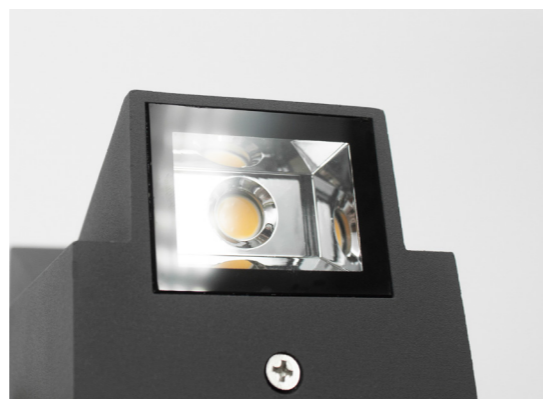

OLP2025-COB 3W+3W BK

Series	Outdoor wall light
LED	COB
CCT	3000K
CRI	RA ≥ 80
Power	2x3w
Luminous Flux	380 Lm
Beam Angle	120°
Color	Graphite
Material	Aluminum
Size	L 82 x W 65 x H 147

OLP5012-COB 6W+6W BK

Series	Outdoor wall light
LED	COB
CCT	3000K
CRI	RA ≥ 80
Power	2x6w
Luminous Flux	720 Lm
Beam Angle	120°
Color	Graphite
Material	Aluminum
Size	D 57 x H 150 x W 80





OLP23703-COB 3W+3W BK

Series	Outdoor wall light
LED	SMD2835
CCT	3000K
CRI	RA ≥ 80
Power	2x3w
Luminous Flux	320 Lm
Beam Angle	120 °
Color	Graphite
Material	Aluminum
Size	L 105 x W 100 x H 133

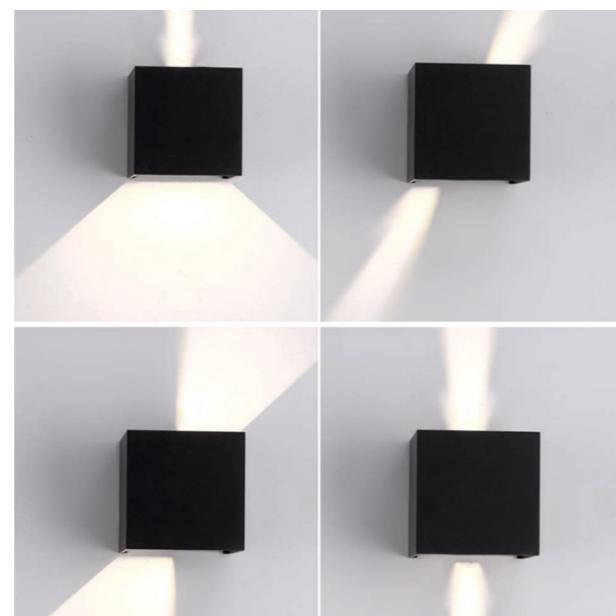



OLP2234-COB 6W+6W BK

Series	Outdoor wall light
LED	SMD2835
CCT	3000K
CRI	RA ≥ 80
Power	2x6w
Luminous Flux	700 Lm
Beam Angle	120°
Color	Graphite
Material	Aluminum
Size	D 92 x H 132 x W 127





SP29 BK-100w

Series	Floodlight
LED	SMD
CCT	6400K
CRI	RA ≥ 80
Power	100w
Luminous Flux	12000 Lm
Beam Angle	120 °
Color	Black
Material	Aluminum
Size	D 300 x H 160



SP29 BK-150w

Series	Floodlight
LED	SMD
CCT	6400K
CRI	RA ≥ 80
Power	150w
Luminous Flux	18000 Lm
Beam Angle	120 °
Color	Black
Material	Aluminum
Size	D 355 x H 170



SP29 BK-200w

Series	Floodlight
LED	SMD
CCT	6400K
CRI	RA ≥ 80
Power	200w
Luminous Flux	24000 Lm
Beam Angle	120 °
Color	Black
Material	Aluminum
Size	D 400 x H 180





SP18 BK-10w



Series	Floodlight
LED	SMD
CCT	6400K
CRI	RA ≥ 80
Power	10w
Luminous Flux	800 Lm
Beam Angle	120 °
Color	Black
Material	Aluminum
Size	L 90 x W 70 x H 20



SP18 BK-20w



Series	Floodlight
LED	SMD
CCT	6400K
CRI	RA ≥ 80
Power	20w
Luminous Flux	1600 Lm
Beam Angle	120 °
Color	Black
Material	Aluminum
Size	L 143 x W 120 x H 25

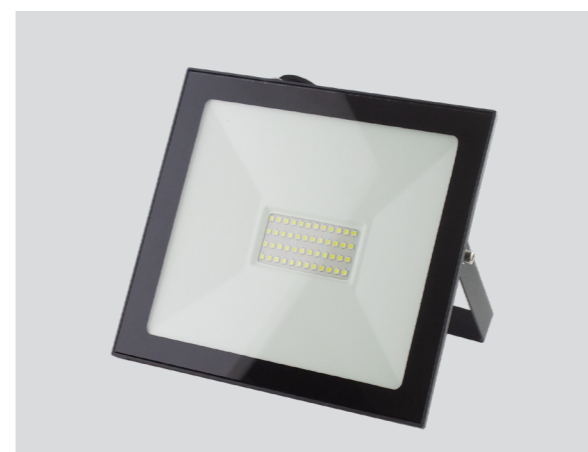

SP18 BK-50w



Series	Floodlight
LED	SMD
CCT	6400K
CRI	RA ≥ 80
Power	50w
Luminous Flux	4000 Lm
Beam Angle	120 °
Color	Black
Material	Aluminum
Size	L 215 x W 180 x H 30



SP18 BK-30w



Series	Floodlight
LED	SMD
CCT	6400K
CRI	RA ≥ 80
Power	30w
Luminous Flux	2400 Lm
Beam Angle	120 °
Color	Black
Material	Aluminum
Size	L 173 x W 150 x H 28

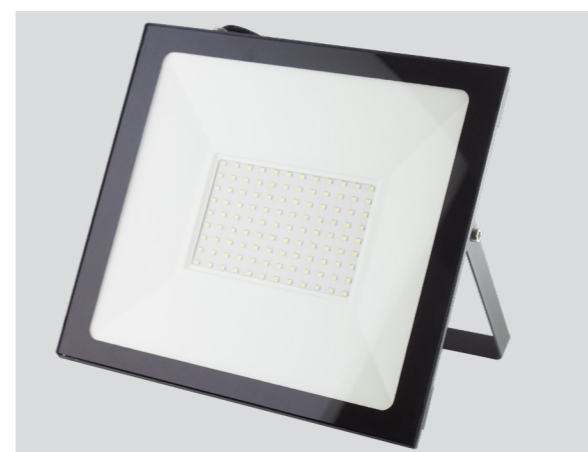

SP18 BK-100w



Series	Floodlight
LED	SMD
CCT	6400K
CRI	RA ≥ 80
Power	100w
Luminous Flux	8000 Lm
Beam Angle	120 °
Color	Black
Material	Aluminum
Size	L 287 x W 255 x H 30

Interior
solution





LINEAR LIGHTING SYSTEM

Contents

- 01** LED strip
- 02** LED profile
- 03** Power supply



- **LED strip**
series

LED ЛЕНТА

успешно заменяет традиционные ламповые источники света. Она используется для основного освещения помещений. А так же для подсветки интерьеров и для уличного освещения. В транспорте, в витринах торговых помещений, для ландшафта и в качестве света для промышленных и складских зданий.

LED LV-2835-120

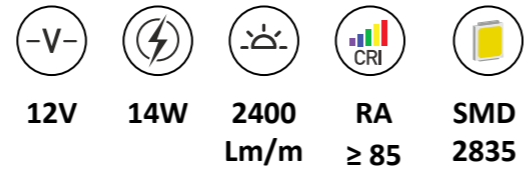
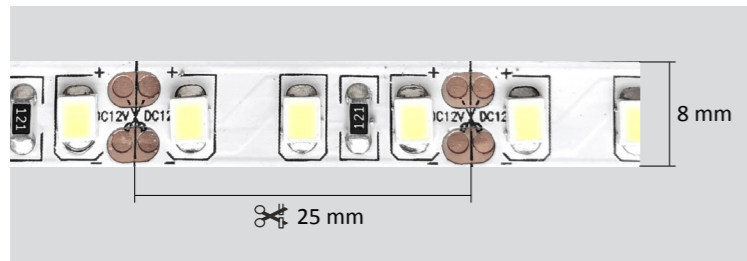

Parameters

LED LV-2835-120 рекомендуется для освещения интерьеров домов, квартир, кафе, ресторанов, гостиниц. Размещается в нишах декоративной подсветки многоуровневых потолков либо в линейных светильниках изготовленных на основе алюминиевых профилей с рассеивающими линзами.

Series	Led strip
LED	SMD 2835
LED/m	120
CRI	RA ≥ 85
Power	14w
Luminous Flux	2400 Lm/m
Voltage	12V
IP	20

IP20

Code

Colour temperature

LED LV-2835-120 3000 K

 Warm white 3000 K

LED LV-2835-120 4000 K

 Neutral white 4000 K

LED LV-2835-120 6000 K

 Cold white 6000 K

Warm white 3000 K



Neutral white 4000 K



Cold white 6000 K



LED LV-5050-60

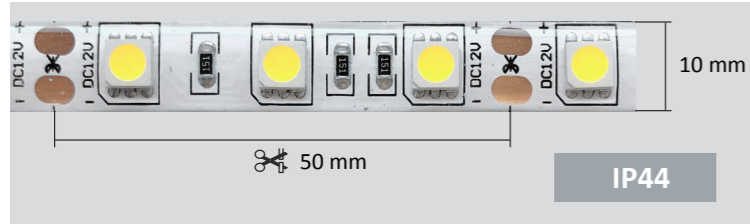
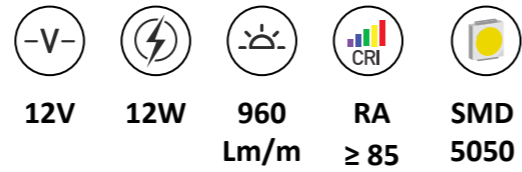
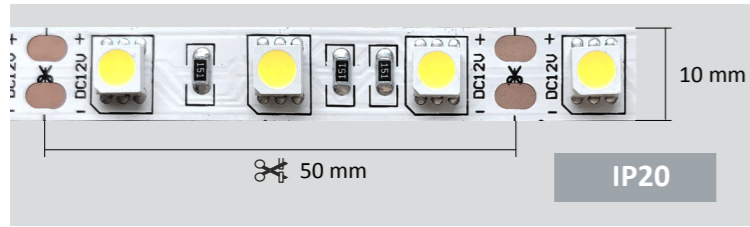

Parameters

LED LV-5050-60 рекомендуется для освещения интерьеров домов, квартир, кафе, ресторанов, гостиниц. Размещается в нишах декоративной подсветки многоуровневых потолков либо в линейных светильниках изготовленных на основе алюминиевых профилей с рассеивающими линзами.

Series	Led strip
LED	SMD 5050
LED/m	60
CRI	RA ≥ 80
Power	12W
Luminous Flux	960 Lm/m
Voltage	12V
IP	20/44

IP20

Code

Colour temperature

LED LV-5050-60 3000 K	—	Warm white 3000 K
LED LV-5050-60 4000 K	—	Neutral white 4000 K
LED LV-5050-60 6000 K	—	Cold white 6000 K

IP44

Code

Colour temperature

LED LV-5050-60 IP44 3000 K	—	Warm white 3000 K
LED LV-5050-60 IP44 4000 K	—	Neutral white 4000 K
LED LV-5050-60 IP44 6000 K	—	Cold white 6000 K



Warm white 3000 K

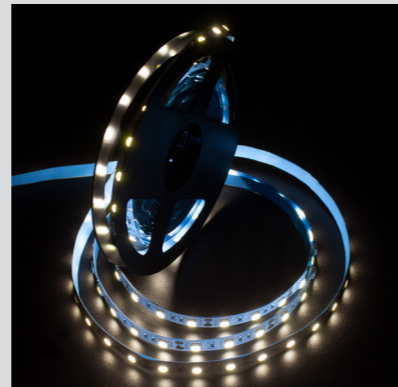

Neutral white 4000 K



Cold white 6000 K



LED WYJ-2835-120

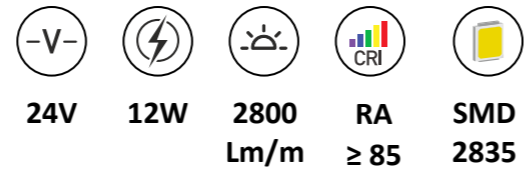
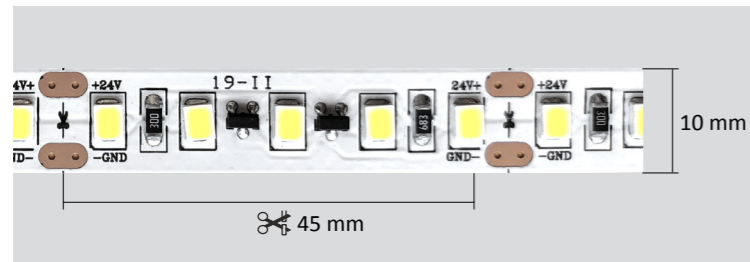

Parameters

LED WYJ-2835-120 рекомендуется для освещения интерьеров домов, квартир, кафе, ресторанов, гостиниц. Размещается в нишах декоративной подсветки многоуровневых потолков либо в линейных светильниках изготовленных на основе алюминиевых профилей с рассеивающими линзами.

Series	Led strip
LED	SMD 2835
LED/m	120
CRI	RA ≥ 80
Power	12W
Luminous Flux	2800 Lm/m
Voltage	24V
IP	20

IP20

Code

Colour temperature

LED WYJ-2835-120 3000 K		Warm white 3000 K
LED WYJ-2835-120 4000 K		Neutral white 4000 K
LED WYJ-2835-120 6000 K		Cold white 6000 K



Warm white 3000 K



Neutral white 4000 K

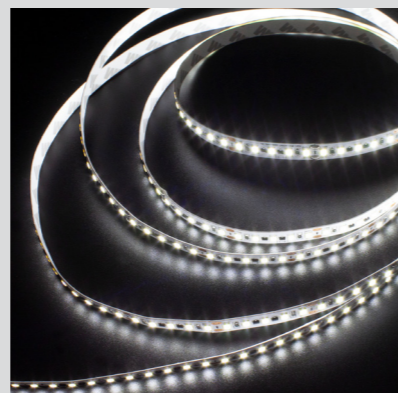

Cold white 6000 K



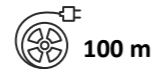
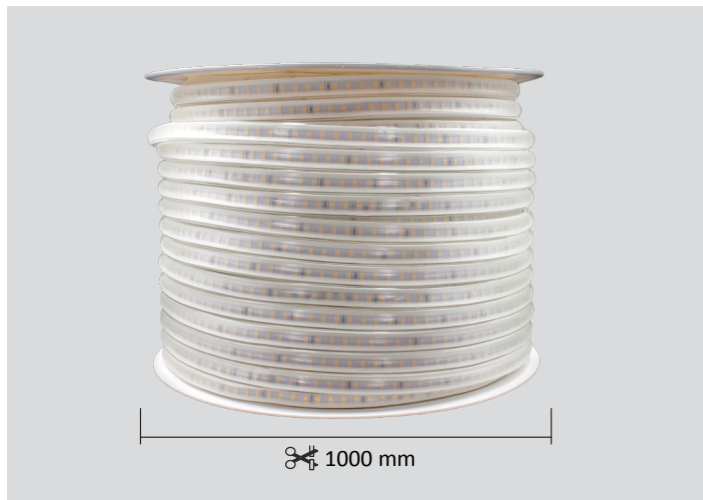

LED 2835-120-SL



220V 8W 2400 Lm/m RA ≥ 85 SMD 2835

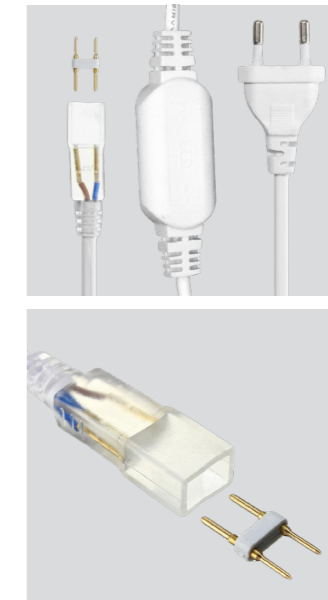

LED Plug-8A

Series	Led strip
Power	8A
Voltage	220V
Size	0,5 m

Parameters

LED 2835-120-SL рекомендуется для освещения интерьеров домов, квартир, кафе, ресторанов, гостиниц. Размещается в нишах декоративной подсветки многоуровневых потолков либо в линейных светильниках изготовленных на основе алюминиевых профилей с рассеивающими линзами.

Series	Led strip
LED	SMD 2835
LED/m	120
CRI	RA ≥ 85
Power	8W
Luminous Flux	2400 Lm/m
Voltage	220V
IP	65

IP65

Code

Colour temperature

LED 2835-120-SL 3000 K	—	Warm white 3000 K
LED 2835-120-SL 4000 K	—	Neutral white 4000 K
LED 2835-120-SL 6000 K	—	Cold white 6000 K



Warm white 3000 K



Neutral white 4000 K



Cold white 6000 K





- **Led profile**
series

LED ПРОФИЛЬ

светодиодная лента в сочетании с LED профилем из алюминия представляет собой полноценный осветительный прибор. Такой способ установки обеспечивает длительный срок эксплуатации конструкции, за счет высокого защитного эффекта против механических повреждений. Форма профиля позволяет гармонично вписать конструкцию в любой дизайн помещения.

LED PXG-2040

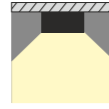
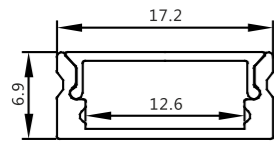

Accessories



Series	Led profile
Material	Aluminum / Polycarbonate
Color	Silver / Opal
Size	17,2 x 12,6 x H 6,9
Maximum length	L= 3m

LED PXG-1204

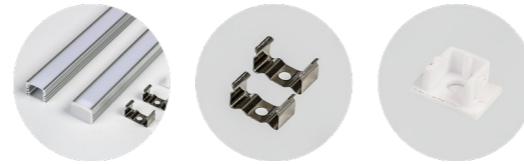
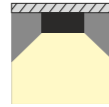
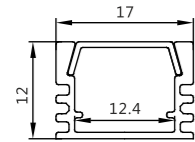

Accessories



Series	Led profile
Material	Aluminum / Polycarbonate
Color	Silver / Opal
Size	17 x 12,4 x H 12
Maximum length	L= 3m

LED PXG-1203

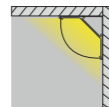
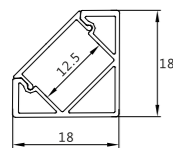

Accessories



Series	Led profile
Material	Aluminum / Polycarbonate
Color	Silver / Opal
Size	12,5 x H 18 x H 2 18
Maximum length	L= 3m



LED PXG-3535-M

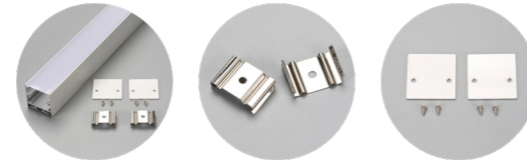
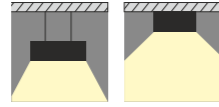
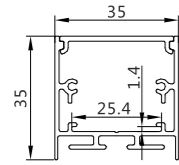

Accessories

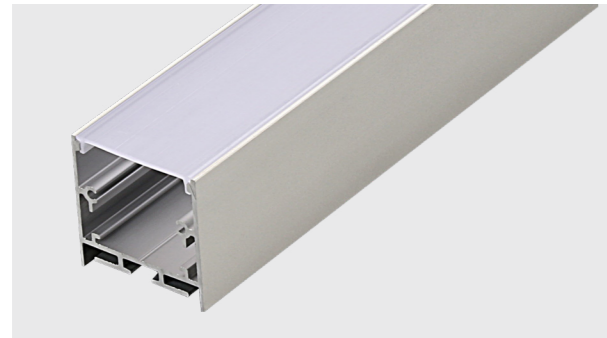

Series	Led profile
Material	Aluminum / Polycarbonate
Color	Silver / Opal
Size	l 35 x l 25,4 x H 35 x h 1,4
Maximum length	L= 3m

LED PXG-5575-M

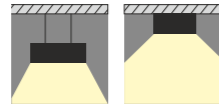
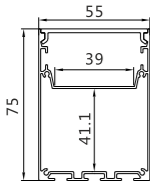

Accessories



Series	Led profile
Material	Aluminum / Polycarbonate
Color	Silver / Opal
Size	l 55 x l 39 x H 75 x h 41,1
Maximum length	L= 3m

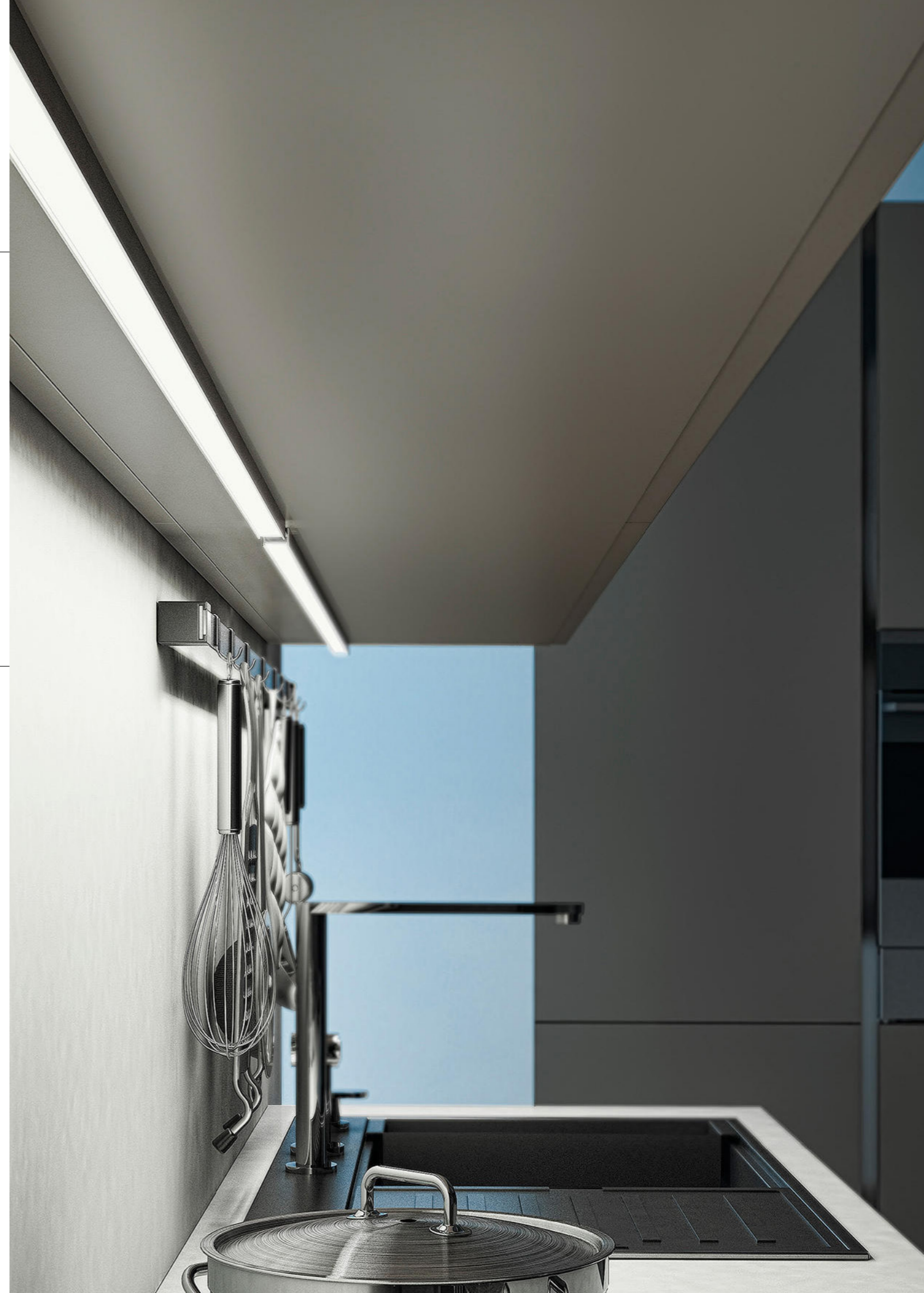

LED PXG-1204-A

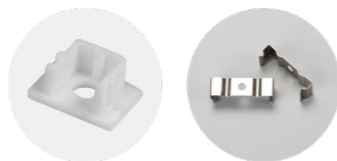
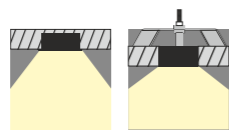
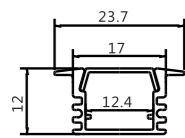

Accessories



Series	Led profile
Material	Aluminum / Polycarbonate
Color	Silver / Opal
Size	l 23,7 x l ₁ 12,4 x H 12 x l ₂ 17
Maximum length	L= 3m

LED PXG-2050

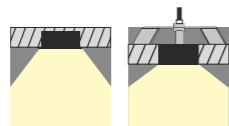
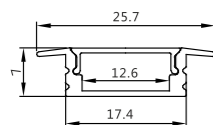

Accessories



Series	Led profile
Material	Aluminum / Polycarbonate
Color	Silver / Opal
Size	l 25,7 x l ₁ 12,6 x H 7 x l ₂ 17,4
Maximum length	L= 3m

LED PXG-3010-A

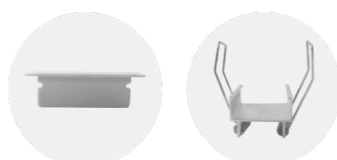
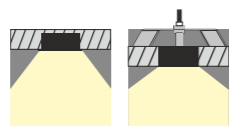
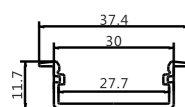

Accessories



Series	Led profile
Material	Aluminum / Polycarbonate
Color	Silver / Opal
Size	l 37,4 x l ₁ 27,7 x H 11,7 x l ₂ 30
Maximum length	L= 3m

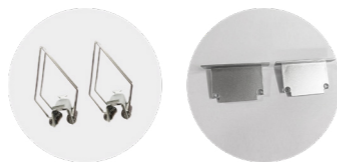
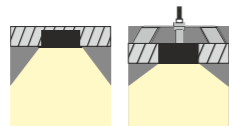
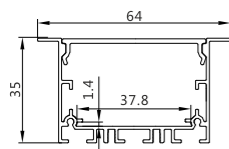

LED PXG-5035-A

Accessories

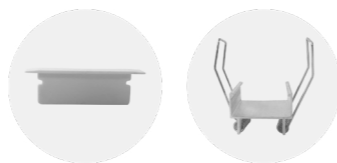
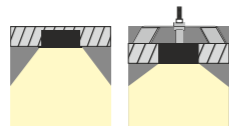
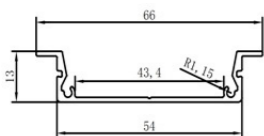

Series	Led profile
Material	Aluminum / Polycarbonate
Color	Silver / Opal
Size	l 64 x l ₁ 37,8 x H 35
Maximum length	L= 3m

LED PXG-6613-A

Accessories

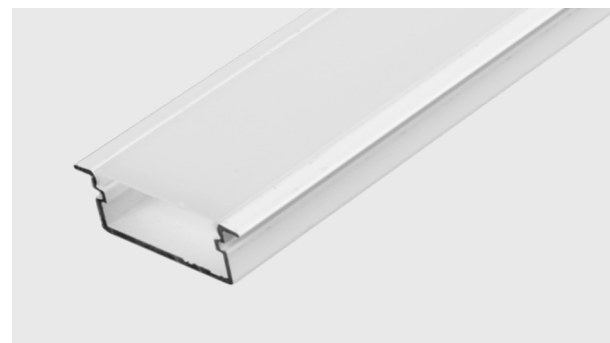

Series	Led profile
Material	Aluminum / Polycarbonate
Color	Silver / Opal
Size	l 66 x l ₁ 43,4 x H 13 x l ₂ 54
Maximum length	L= 3m

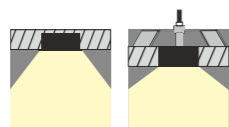
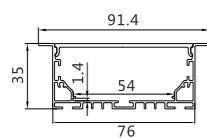
LED PXG-7635-A

Accessories

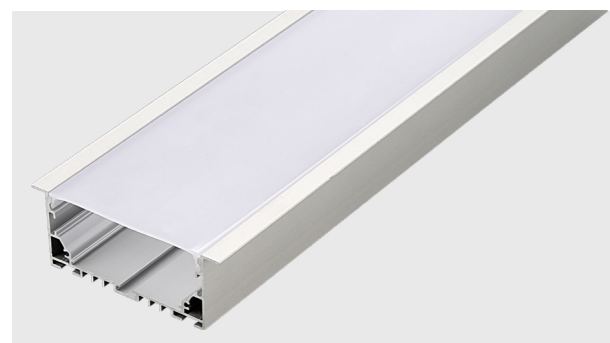

Series	Led profile
Material	Aluminum / Polycarbonate
Color	Silver / Opal
Size	l 91,4 x l ₁ 54 x H 35 x l ₂ 76
Maximum length	L= 3m



LINEAR LIGHTING SYSTEM



LED PXG-304

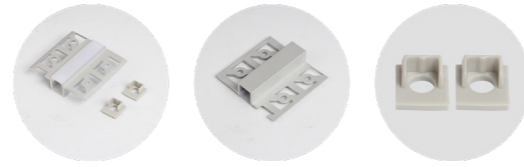
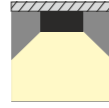
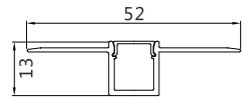

Accessories

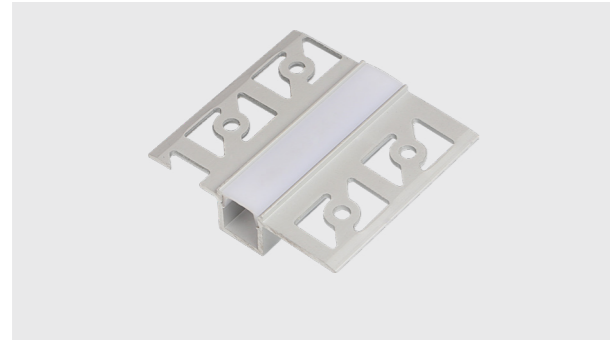

Series	Led profile
Material	Aluminum / Polycarbonate
Color	Silver / Opal
Size	l 52 x l 19 x H 13
Maximum length	L=4m

LED PXG-303

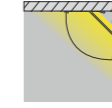
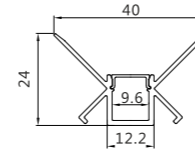

Accessories



Series	Led profile
Material	Aluminum / Polycarbonate
Color	Silver / Opal
Size	l 40 x l 19,6 x H 24
Maximum length	L=4m

LED PXG-305

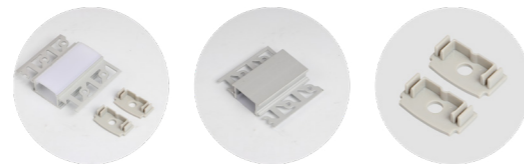
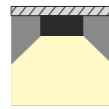
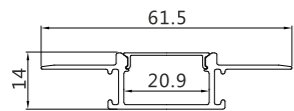

Accessories



Series	Led profile
Material	Aluminum / Polycarbonate
Color	Silver / Opal
Size	l 61,5 x l 20,9 x H 14
Maximum length	L= 3m

LED PXG-30

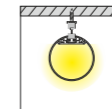
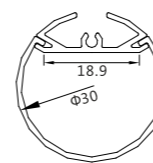

Accessories



Series	Led profile
Material	Aluminum / Polycarbonate
Color	Silver / Opal
Size	D 30 x l 18
Maximum length	L= 3m

LED PXG-302

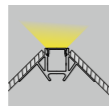
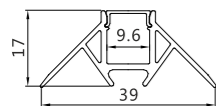

Accessories



Series	Led profile
Material	Aluminum / Polycarbonate
Color	Silver / Opal
Size	l 39 x l 19,6 x H 17
Maximum length	L= 4m

LED PXG-60

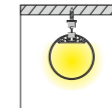
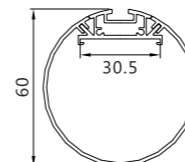

Accessories



Series	Led profile
Material	Aluminum / Polycarbonate
Color	Silver / Opal
Size	D 60 x l 30
Maximum length	L= 3m



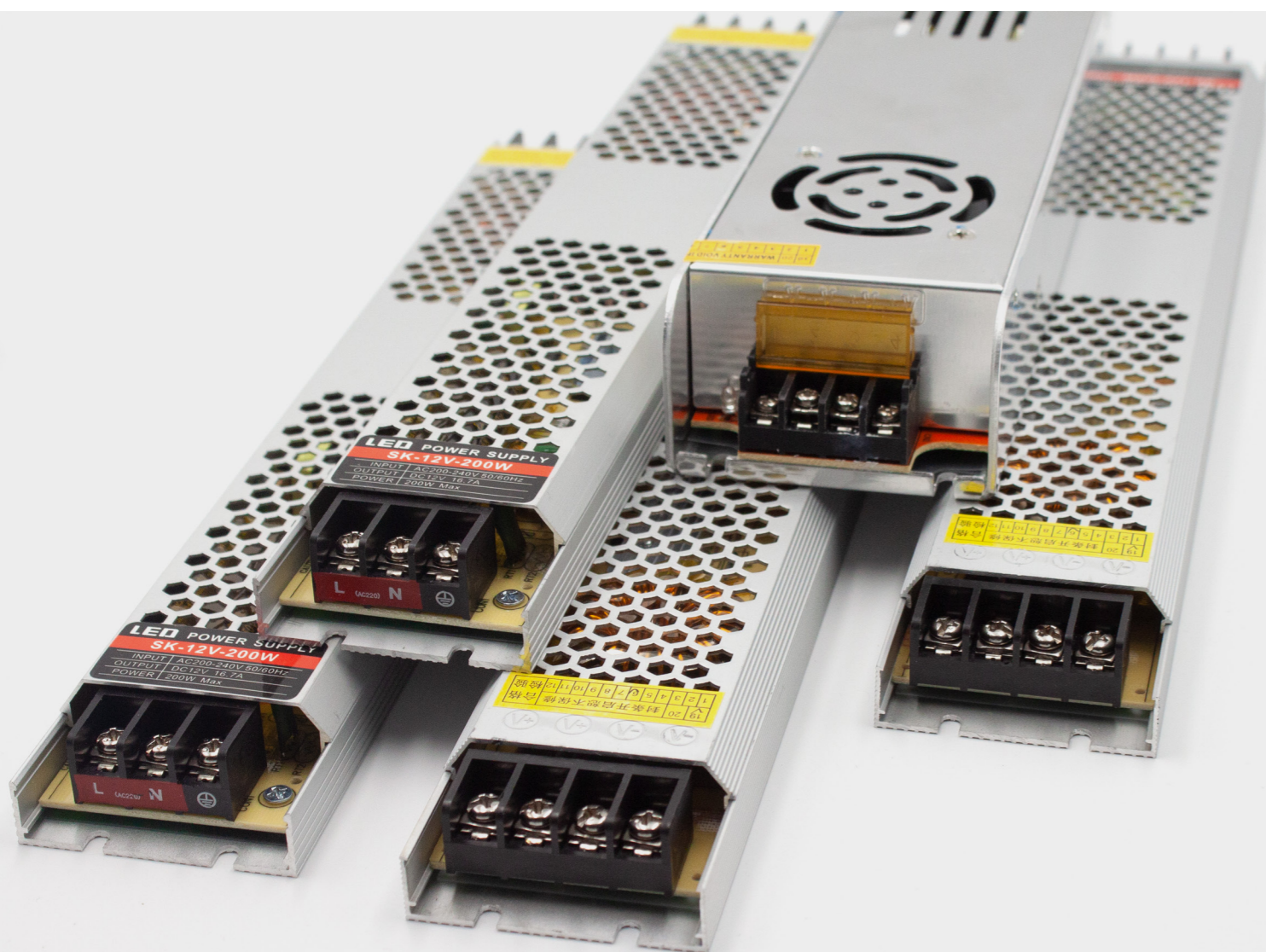

Power supply series

БЛОКИ ПИТАНИЯ

основная функция - снабжение светодиодов электрической энергией нужных параметров. Кроме того они стабилизируют напряжение и необходимы для выполнения определенных защитных функций. Позволяют увеличить срок эксплуатации светодиодных источников света, позволяя тем самым добиться максимальной производительности и эффективности работы всей системы.

	Size	Weight	Power output	Output voltage	Output current	IP
LED PS60/12-IP20	L ₁ = 202 mm L ₂ = 53 mm H =21 mm	165 g	60W	12V	5A	IP20
LED PS150/12-IP20	L ₁ = 269 mm L ₂ = 53 mm H =21 mm	241 g	150W	12V	12,5A	IP20
LED PS200/12-IP20	L ₁ = 315 mm L ₂ = 53 mm H =21 mm	310 g	200W	12V	16,7A	IP20
LED PS300/12-IP20	L ₁ = 348 mm L ₂ = 53 mm H =21 mm	346 g	300W	12V	25A	IP20

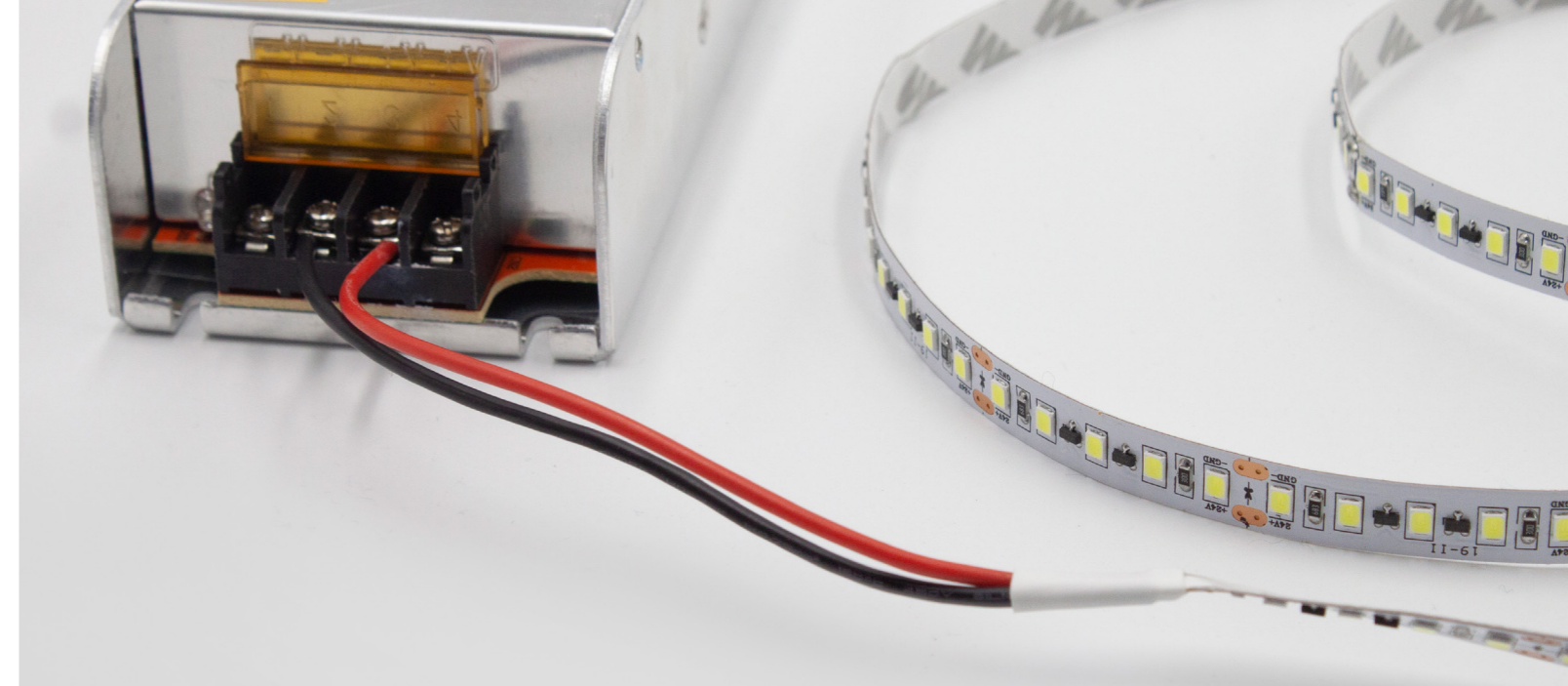
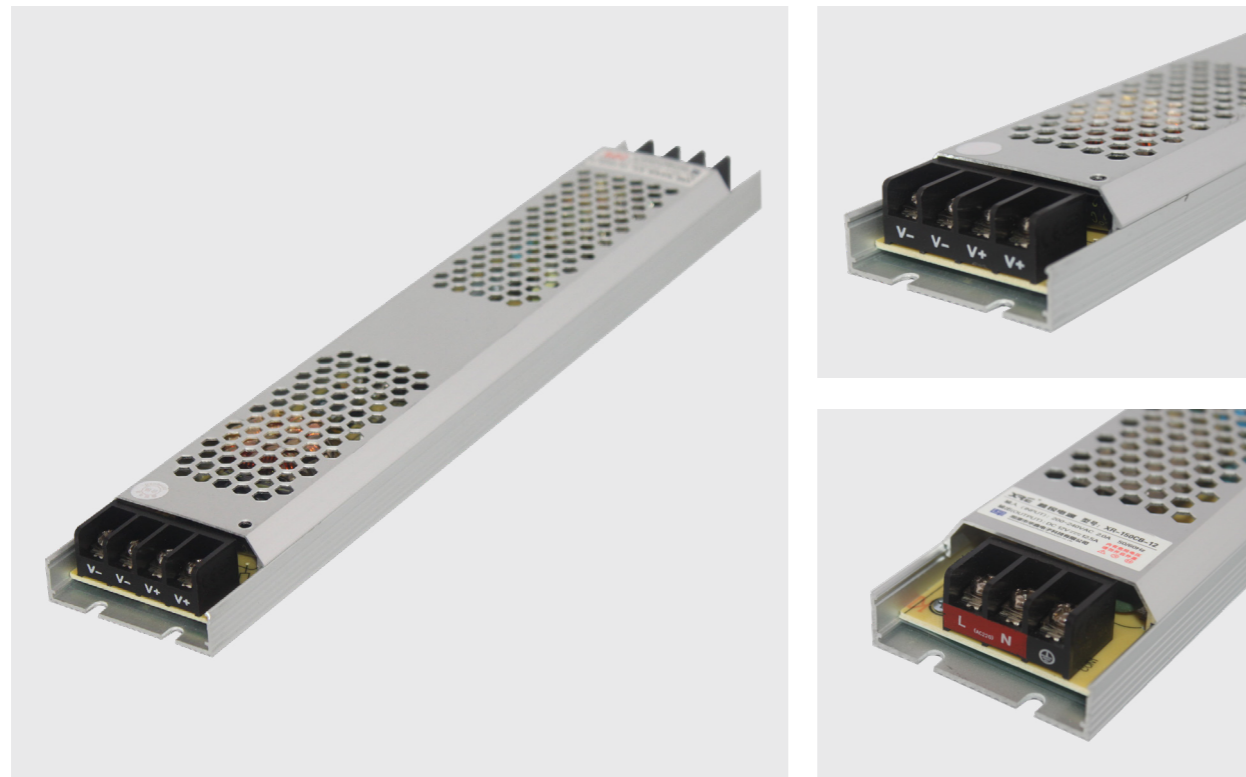

	Size	Weight	Power output	Output voltage	Output current	IP
LED PS360/24-IP20	L ₁ =225 mm L ₂ =68 mm H =40 mm	320 g	360W	24V	15A	IP20



